

Serie **DECO**

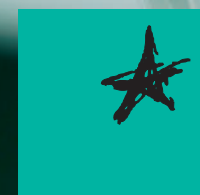

ARIES

SerieDECO

SerieDECO nasce dall'esigenza espressa da molti professionisti di coniugare estetica e funzionalità. Soluzioni tecniche all'avanguardia sono combinate ai materiali più moderni. La struttura dei mobili è in lamiera di acciaio elettrozincata verniciata a polveri epossidiche. SerieDECO viene proposta in due varianti di design: linea **D**, con i frontali in poliuretano e linea **M** in lamiera elettrozincata con maniglia in alluminio.

SerieDECO arose from the need expressed by many professionals to find a successful mix of design and function. Cutting edge technological solutions are combined with the apex of modern materials. The unit frames are made of electro-galvanised steel with an epoxy powder coated paint finish. SerieDECO is offered in two design variations: Linea **D**, with polyurethane front panels and Linea **M** in galvanised steel and aluminium handles.

Née de l'exigence, exprimée par de nombreux professionnels, de marier esthétique et fonctionnalité, SerieDECO offre des solutions techniques d'avant-garde associées à des matériaux novateurs. La structure des meubles est en acier électro-zingué laqué avec des poudres époxydiques. SerieDECO est proposée en deux modèles différents: la Ligne **D**, avec des façades en polyuréthane et la Ligne **M** en tôle électro-zinguée avec des poignées en aluminium.

SerieDECO entspringt dem von vielen Zahnärzten geäußerten Wunsch, Design und Funktionalität unter einen Hut zu bekommen. Zukunftsgerichtete technische Lösungen werden kombiniert mit modernsten Materialien. Die Struktur der Möbel besteht aus elektroverzinktem Stahlblech mit Epoxydpulverbeschichtung. SerieDECO präsentiert sich in zwei Designausführungen: Linea **D** mit Fronten aus Polyurethan und Linea **M** aus elektroverzinktem Blech mit Aluminiumgriff.

SerieDECO nace de la exigencia expresada por muchos profesionales de conjugar estética y funcionalidad. Soluciones técnicas a la vanguardia se combinan con los materiales más modernos. La estructura de los muebles está realizada con chapa de acero electrogalvanizada pintada con polvos epoxídicos. SerieDECO se propone en dos variantes de diseño: Linea **D**, con las partes frontales de poliuretano, y Linea **M**, de chapa electrogalvanizada con tirador de aluminio.

linea **D**

linea **M**

linea **D**



SerieDECO



SerieDECO offre la migliore componentistica come ad esempio i cassetti ad estrazione totale con rientro ammortizzato "blumotion".
Se l'armonia delle forme e la praticità sono le qualità che cercate le troverete in SerieDECO.

SerieDECO offers only the best in components like, for instance, the full extension drawers with "blumotion" soft closure. If you are looking for harmony of shape and practicality, you will definitely find these qualities in SerieDECO.

SerieDECO offre les meilleurs composants comme par exemple des tiroirs à sortie totale pourvus d'une fermeture amortie "blumotion". Si l'harmonie des formes et la commodité sont les qualités que vous recherchez, SerieDECO est faite pour vous.

SerieDECO bietet beste Komponenten wie zum Beispiel die Vollauszug-Schubladen mit stoßgedämpftem Schließmechanismus "Blumotion". Wenn Sie auf der Suche sind nach harmonischen Formen und Zweckmäßigkeit, dann wird Sie die SerieDECO überzeugen.

SerieDECO ofrece los mejores componentes como, por ejemplo, los cajones de extracción total con retorno amortiguado "blumotion". Si la armonía de las formas y la facilidad de utilización son las cualidades que busca, las encontrará en SerieDECO.

linea D

Its graceful shapes blend harmoniously with the design of the modular assemblies and offer optimum ergonomics in the work environment. SerieDECO has been studied to fit into any dental surgery, every design solution just falls perfectly into place.

Ses formes sinueuses s'harmonisent au design des modules assemblés et permettent une meilleure ergonomie du lieu de travail. SerieDECO a été étudiée pour s'intégrer parfaitement au cabinet dentaire et chacune des solutions conceptuelles proposées y trouve parfaitement sa place.

Ihre abgerundeten Formen harmonisieren mit dem Design der Module und erlauben eine bessere Ergonomie am Arbeitsplatz. SerieDECO wurde entwickelt, um sich vollständig in die Zahnarztpraxis einzupassen, und jede Projektlösung findet den richtigen Platz.

Sus formas sinuosas se armonizan con el diseño de los módulos ensamblados y permiten una mejor ergonomía dentro del local de trabajo. SerieDECO ha sido estudiada para integrarse completamente en la clínica: cada solución de proyecto encuentra su colocación ideal.

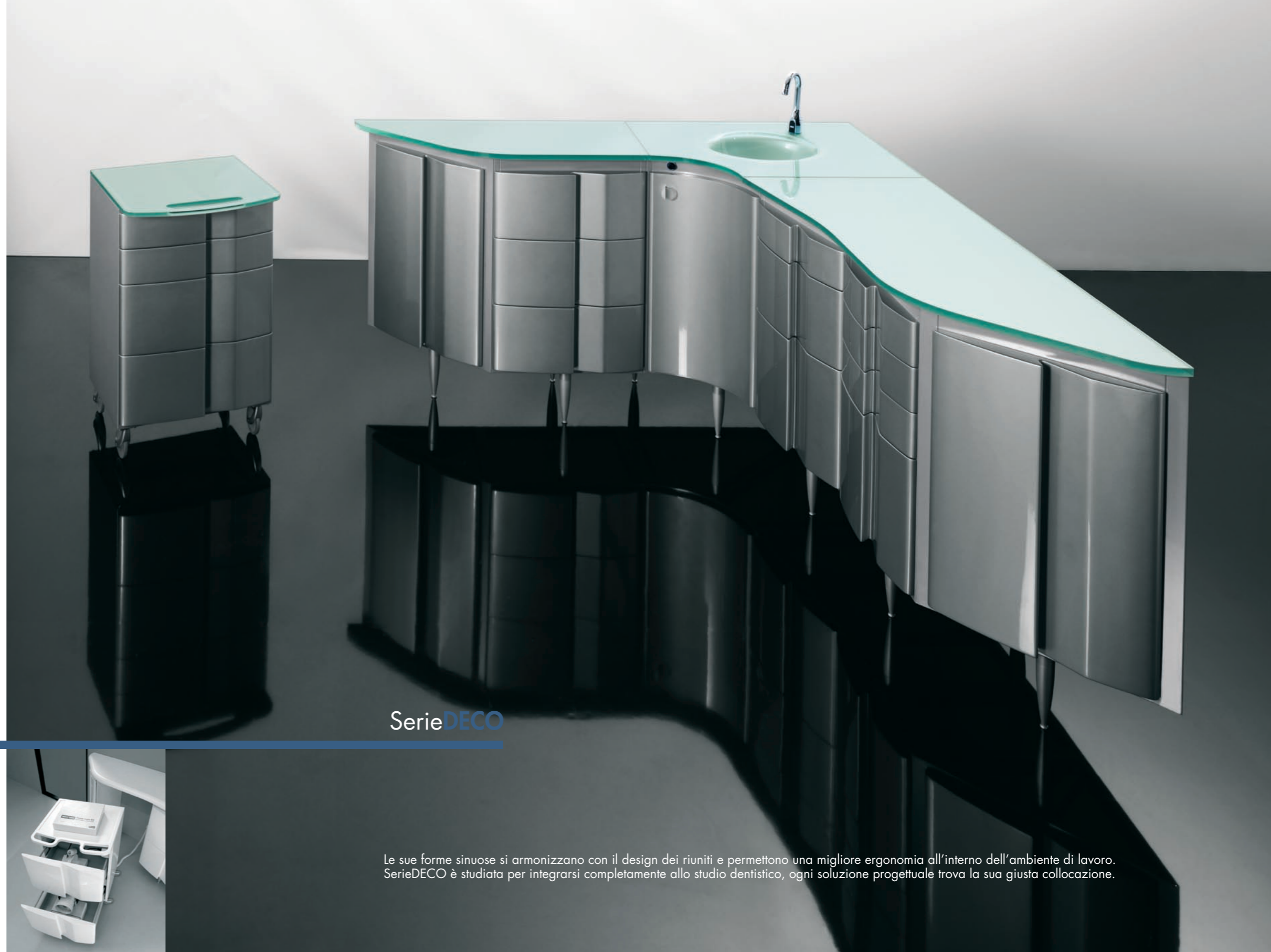

SerieDECO

Le sue forme sinuose si armonizzano con il design dei riuniti e permettono una migliore ergonomia all'interno dell'ambiente di lavoro. SerieDECO è studiata per integrarsi completamente allo studio dentistico, ogni soluzione progettuale trova la sua giusta collocazione.

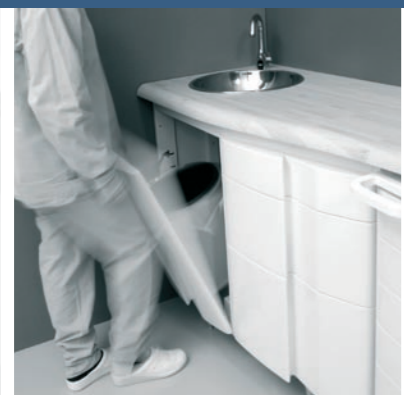



linea D

The innovative front panel with integral handle makes daily cleaning effortless. SerieDECO offers a wide range of modules and accessories to satisfy every need.

Une façade novatrice à poignée intégrée facilite les opérations quotidiennes de nettoyage. SerieDECO offre une vaste gamme de modules et d'accessoires qui permettent de satisfaire toutes les exigences.

Die innovative Front mit integriertem Griff erleichtert die täglichen Reinigungsarbeiten. SerieDECO bietet eine breitgefächerte Auswahl an Modulen und Zubehörteilen, die allen Anforderungen gerecht werden.

La innovadora parte frontal con tirador integrado facilita las operaciones de limpieza cotidianas. SerieDECO ofrece una amplia gama de módulos y accesorios que satisfacen cualquier exigencia.

SerieDECO

L'innovativo frontale con maniglia integrata facilita le quotidiane operazioni di pulizia. SerieDECO offre una ampia gamma di moduli ed accessori che soddisfano ogni esigenza.



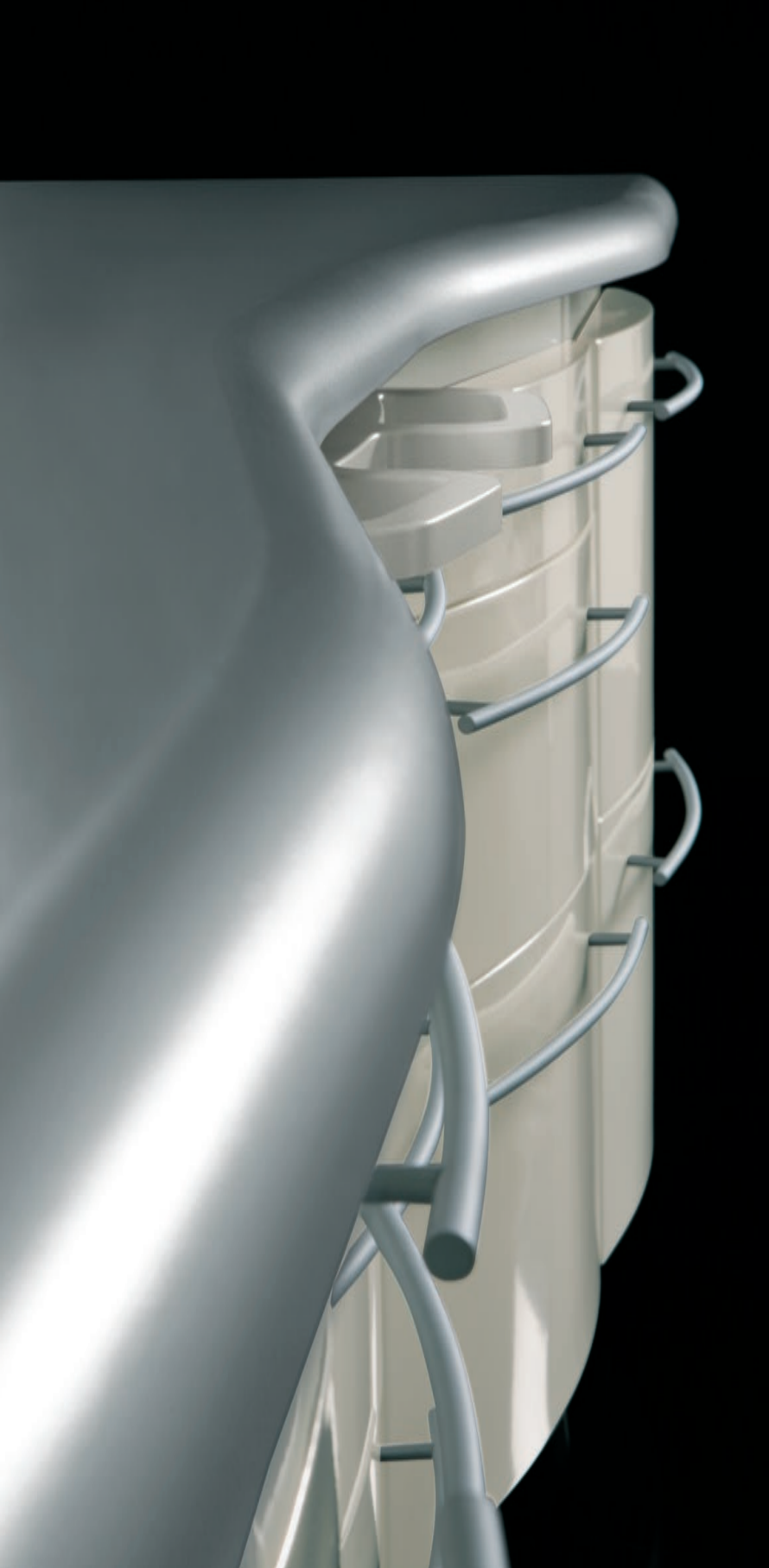

linea **M**

linea **M**



Linea M: il frontale bombato con maniglia in alluminio si fonde in linee morbide e classiche che si armonizzano in ogni ambiente. SerieDECO non finirà mai di stupirvi con le sue infinite trasformazioni. Unica nel suo genere, dotata di un fascino inimitabile, questi mobili diventeranno i veri protagonisti del vostro studio dentistico.



Serie**DECO**

Linea M: the curved front panel with aluminium handle merges into soft, classic contours that blend harmoniously into any surroundings. SerieDECO will never stop astounding you with its infinite transformations. One of its kind, with an unparalleled charisma, these units are destined to become the true highlight of your dental surgery.

Ligne M: la façade bombée à poignée en aluminium se fond aux lignes douces et classiques qui caractérisent la ligne tout en s'adaptant parfaitement à tout type de lieu. Les innombrables possibilités de transformation de SerieDECO ne finiront jamais de vous surprendre. Uniques dans leur genre et dotés d'un charme inimitable, ces meubles deviendront les véritables protagonistes de votre cabinet dentaire.

Linea M: Die gewölbte Front mit Aluminiumgriff löst sich auf in weiche und klassische Linien, die in jedes Ambiente passen. Die SerieDECO wird Sie dank ihrer unendlich vielen Gestaltungsmöglichkeiten stets aufs Neue in Erstaunen versetzen. Einzig in ihrer Art und mit einem unnachahmlichen Charme werden diese Möbel zum Mittelpunkt Ihrer Zahnarztpraxis.

Linea M: la parte frontal curvada con tirador de aluminio se funde en líneas suaves y clásicas que se armonizan en cada ambiente. SerieDECO no dejará nunca de sorprenderle con sus infinitas transformaciones. Única en su género, está dotada de un encanto inimitable: estos muebles se convertirán en los auténticos protagonistas de su clínica.

Piani / Lavelli / Rubinetti

- 01 Art. **TDD/W**: piano mdf bianco / white mdf top
Art. **LX1**: lavello inox / st. steel sink
Art. **GR4**: mixer leva medica / mixer long lever
- 02 Art. **TDD/G**: piano mdf grigio / grey mdf top
Art. **LX1**: lavello inox / st. steel sink
Art. **GR4**: mixer leva medica / mixer long lever
- 03 Art. **TDW/G**: legno con vetro / wood with glass
Art. **LX1**: lavello inox / st. steel sink
Art. **MICRO**: mixer leva medica / mixer long lever

Tops / Sinks / Water-taps

- 04 Art. **TDD/G**: piano mdf grigio / grey mdf top
Art. **LGT**: bacinella in vetro / glass bowl
Art. **SLIM**: mixer leva medica / mixer long lever
- 05 Art. **TVT**: vetro colorato / coloured glass top
Art. **LVT**: lavello integrato / integrated sink
Art. **MICRO**: mixer leva medica / mixer long lever
- 06 Art. **TDC**: piano in Corian® / Corian® top
Art. **LCO**: lavello in Corian® / Corian® sink
Art. **BILLO**: mixer infrarossi / infra-red mixer

Inserti in PST PST inserts

- 01 Art. **PSA**: portastrumenti / instrument holder
- 02 Art. **DIR**: inserto 4 scomparti / 4 compartments insert
- 03 Art. **DIS**: inserto 6 scomparti / 6 compartments insert
- 04 Art. **DIP**: inserto 9 scomparti / 9 compartments insert
- 05 Art. **DIL**: inserto liscio / plain insert
- 06 Art. **SBSA**: inserto 4 scomparti / 4 compartments insert
- 07 Art. **SBLA**: inserto liscio / plain insert



SerieDECO permette soluzioni che ottimizzano lo spazio all'interno del tuo studio. Una vera innovazione rispetto agli arredamenti tradizionali qui sotto evidenziati con tratto rosso.

SerieDECO offers solutions that optimise the space in your surgery. A real innovation compared to the traditional concept of furniture as shown here in red.

SerieDECO apporte des solutions qui permettent d'optimiser l'espace de votre cabinet dentaire. Une véritable innovation par rapport aux ameublements traditionnels signalés ci-dessous par un trait rouge.

Die SerieDECO bietet Möglichkeiten, die das Raumangebot in Ihrer Praxis optimieren. Eine echte Innovation gegenüber den traditionellen Einrichtungen, die hier nachfolgend rot eingezeichnet sind.

SerieDECO permite soluciones que optimizan el espacio dentro de su clínica. Una auténtica innovación respecto a los muebles tradicionales. Observe los ejemplos resalta-dos en rojo.

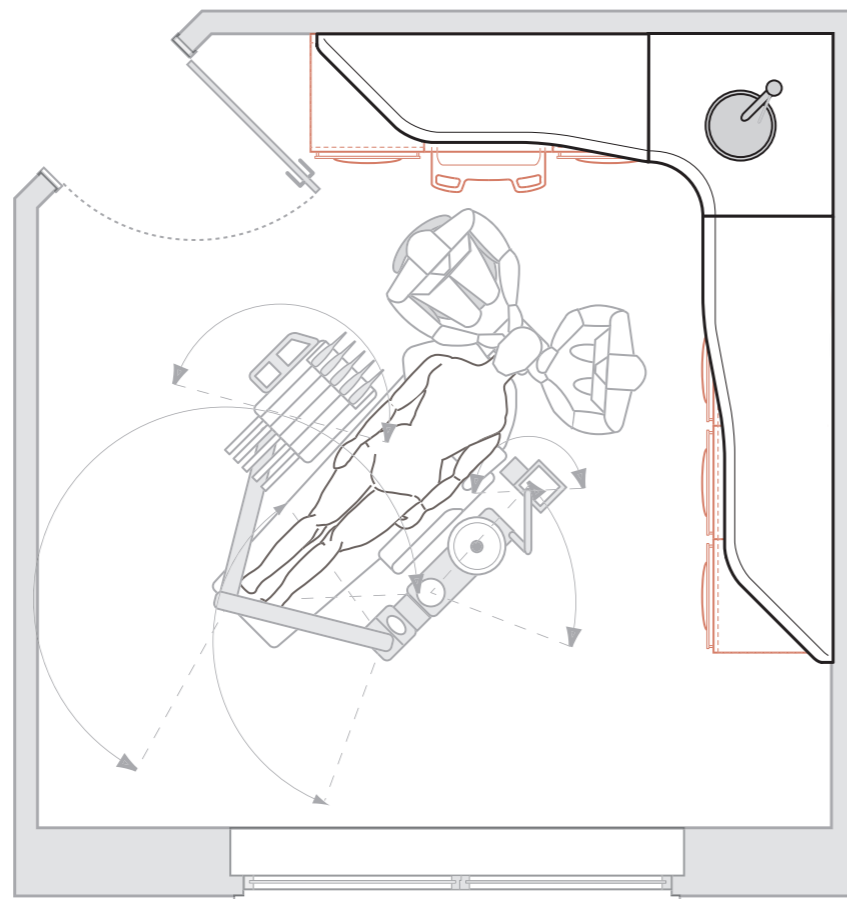

Mq 12,00

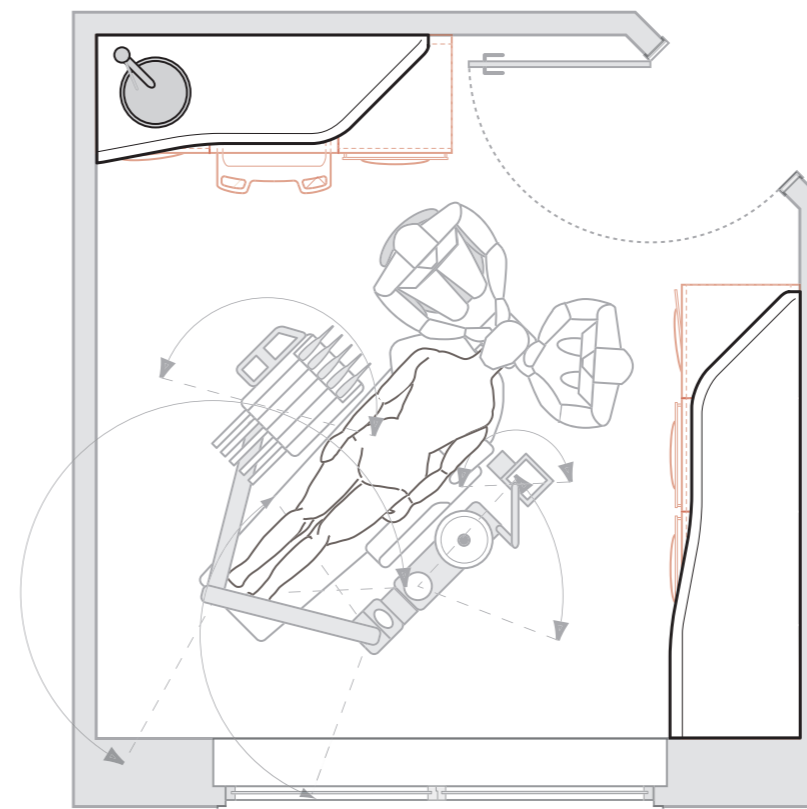

Mq 9,00

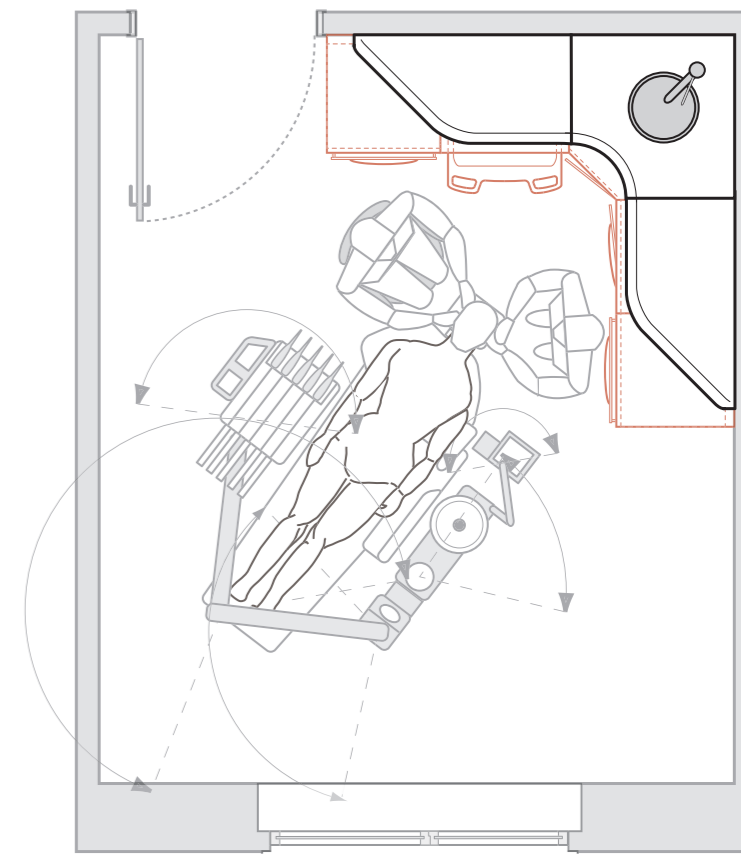

Mq 9,00

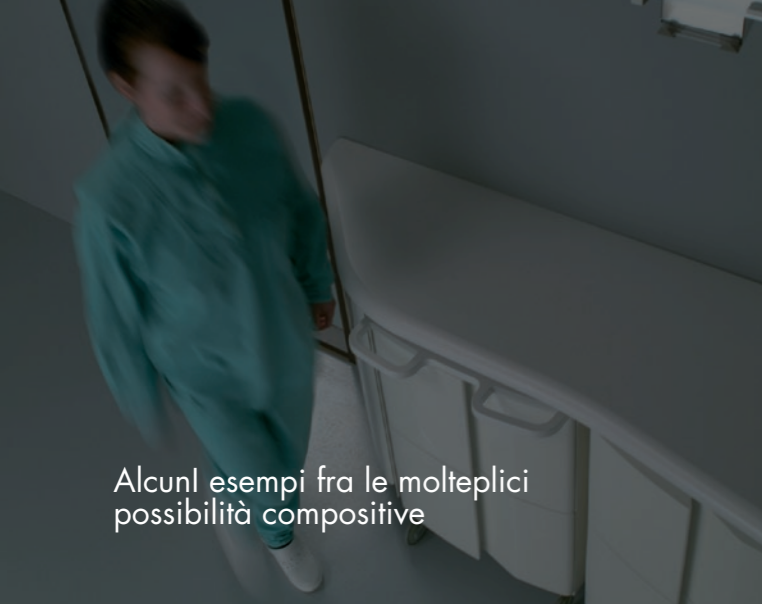

Alcuni esempi fra le molteplici possibilità compositive

A few examples of the many possibilities in layout
 Quelques exemples parmi les multiples possibilités de compositions
 Einige Beispiele für die vielfältigen Gestaltungsmöglichkeiten
 Le presentamos algunos ejemplos de entre las múltiples posibilidades de composición

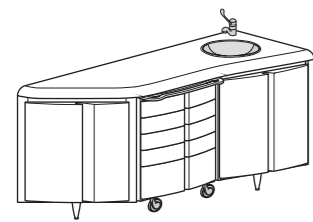

Art. DD1 W 146 /D 56,5 / H 87

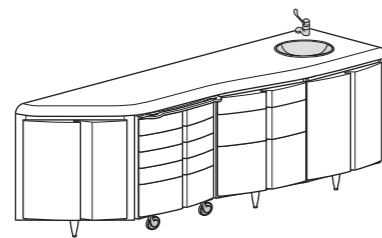

Art. DD2 W 196 /D 56,5 / H 87

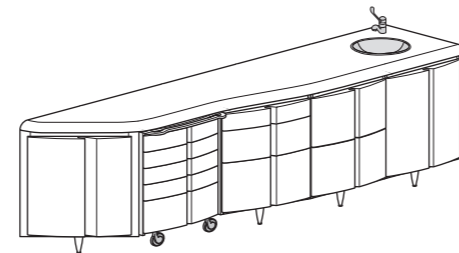

Art. DD3 W 246 /D 56,5 / H 87

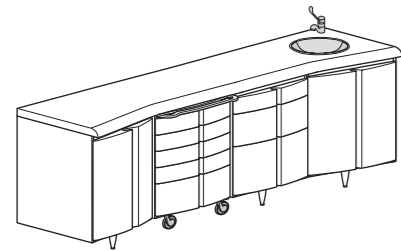

Art. DD5 W 204 /D 56,5 / H 87

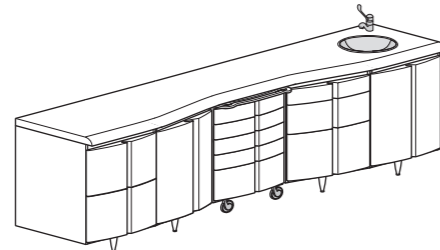

Art. DD6 W 254 /D 56,5 / H 87

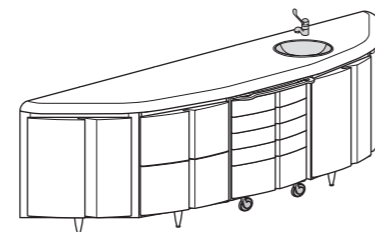

Art. DD8 W 246 /D 56,5 / H 87

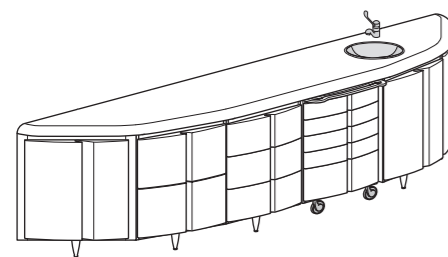

Art. DD9 W 288 /D 56,5 / H 87

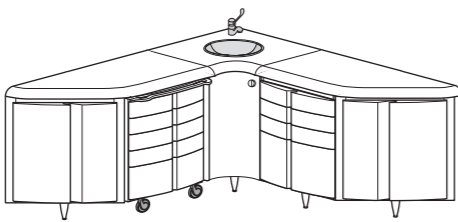

Art. DD10 W 162-166 /D 46,5 / H 87

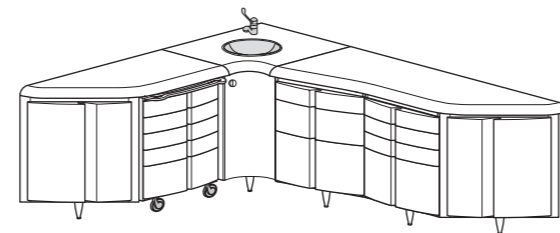

Art. DD11 W 176+214 /D 56,5 / H 87

Campioni top

Top samples
 Gamme plateaux
 Oberflächenmuster
 Muestras encimera

MDF - PVC



TDD / W white



TDD / G grey

Corian®



TDC cameo white

LEGNO / WOOD / BOIS / HOLZ / MADERA



TDW wood



TDW / G wood w/glass

VETRO VERNICIATO / PAINTED GLASS / VERRE VERNI / GLAS LACKIERT / CRISTAL PINTADO



TVT 34 white green

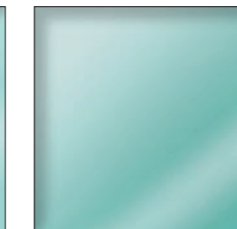

TVT 08 green

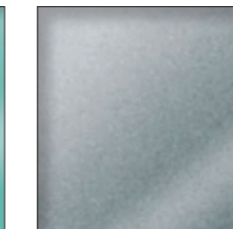

TVT 07 metallized grey

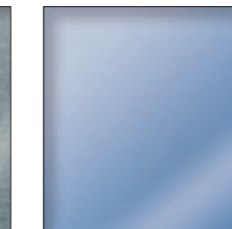

TVT 11 blue

Scala colori

Color sample
 Gamme couleurs
 Farbmuster
 Muestras de colores

STRUTTURA IN METALLO / BODY IN METAL / STRUCTURE EN METAL / METALLKORPUS / ESTRUCTURA METÁLICA

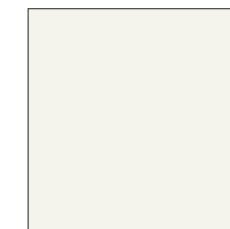

RAL 9010 pure white



Z011 metallic grey

linea D

FRONTALI IN POLIURETANO

Front in polyurethane
 Façades en polyuréthane
 Front in Polyurethan
 Parte frontal de poliuretano



RAL 9010 pure white



ZN22 metallized grey

linea M

FRONTALI IN METALLO

Fronts in metal
 Façades en metal
 Front in Metal
 Parte frontal metálica

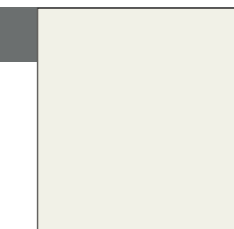

RAL 9010 pure white



Z011 metallic grey

ARIES FURNITURE FOR DENTAL SURGERY AND LABORATORY.

"Authorized Dealer"



Via Venezia, 105
31020 - Tezze di Vazzola
Treviso - Italia
Tel. +39 0438 488183
Fax +39 0438 488187
info@seriedeco.it
www.seriedeco.it

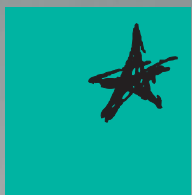

ARIES