

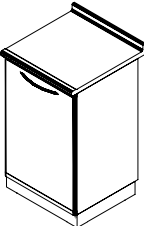

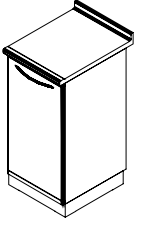
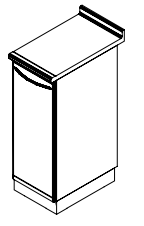

DESCRIZIONE description	ARTICOLO article	EURO		
		laminato	vetro	corian
		laminar	glass	corian
laminé	verre	corian		
 <p>Elemento 1 anta - 2 ripiani 1 door unit - 2 shelves Elément 1 porte - 2 rayons internes</p> <p>L. 50 x p.47 x H.91</p>	T			
 <p>Elemento 1 anta - 2 ripiani (larghezza 40) 1 door unit - 2 shelves (width 40) Elément 1 porte - 2 rayons internes (largeur 40)</p> <p>L. 40 x p.47 x H.91</p>	T400			
 <p>Elemento 1 anta - 2 ripiani (larghezza 30) 1 door unit - 2 shelves (width 30) Elément 1 porte - 2 rayons internes (largeur 30)</p> <p>L. 30 x p.47 x H.91</p>	T300			
 <p>Elemento 3 cassetti B - 1 antina 2 bacinelle - 2 fondi PVC 3 B-drawers - 1 door unit 2 trays - 2 PVC bottoms Elément 3 tiroirs B - 1 porte 2 intérieurs de tiroirsonds - 2 fonds en PVC</p> <p>L. 50 x p.47 x H.91</p>	T3P			
 <p>Elemento 4 cassetti A - 1 B - 1 antina 3 bacinelle - 2 fondi PVC 4 A-drawers - 1 B-drawer - 1 door unit 3 trays - 2 PVC bottoms Elément 4 tiroirs A - 1 tiroir B - 1 porte 3 intérieurs de tiroirs - 2 fonds en PVC</p> <p>L. 50 x p.47 x H.91</p>	T5P			
 <p>Elemento 3 cassetti B - 1 D 2 bacinelle - 2 fondi PVC 3 B-drawers - 1 D-drawer unit 2 trays - 2 PVC bottoms Elément 3 tiroirs B - 1 tiroir D 3intérieurs de tiroirs - 2 fond en PVC</p> <p>L. 50 x p.47 x H.91</p>	T4			
 <p>Elemento 1 cassetto A - 2 B - 2 C 3 bacinelle - 2 fondi PVC 1 A-drawer - 2 B-drawers - 2 C-drawer unit 3 trays - 2 PVC bottoms Elément 1 tiroir A - 2 tiroirs B - 2 tiroirs C 3 intérieurs de tiroirs - 2 fonds en PVC</p> <p>L. 50 x p.47 x H.91</p>	T5			

DESCRIZIONE description	ARTICOLO article	EURO		
		laminato	vetro	corian
		laminar	glass	corian
laminé	verre	corian		
 <p>Elemento 2 cassetti A - 3 B - 1 C 4 bacinelle - 2 fondi PVC 2 A-drawers - 3 B-drawers - 1 C-drawer unit 4 trays - 2 with PVC bottom Elément 2 tiroirs A - 3 tiroirs B - 1 tiroir C 4 intérieurs de tiroirs - 2 fonds en PVC</p> <p>L. 50 x p.47 x H.91</p>	T6			
 <p>Elemento 4 cassetti A -2 B - 1C 5 bacinelle - 2 fondi PVC 4 A-drawers - 2 B-drawers - 1 C-drawer unit 5 trays - 2 PVC bottoms Elément 4 tiroirs A - 2 tiroirs B - 1 tiroir C 5 intérieurs de tiroirs - 2 fonds en PVC</p> <p>L. 50 x p.47 x H.91</p>	T7			
 <p>Elemento 2 piani estraibili portastrumenti antina a scomparsa 1 cassetto A - 1B - 1C 1 bacinella - 2 fondi PVC Unit with 2 movable surgical instruments holders disappearance door 1 A - drawer, 1B drawer, 1C drawer 1 tray- 2 PVC bottoms Elément 2 plans extractibles porte - instruments porte escamotable 1 tiroir A - 1 A -1C-1 intérieur de tiroirs - 2 fonds en PVC</p> <p>L. 50 x p.47 x H.91</p>	TEM2			
 <p>Elemento 1 antina - 5 ripiani lamiera forata lampada ultravioletti 1 door - 5 perforated plate shelves unit U.V. lamp Elément 1 porte - 5 rayons en métal perforée lampe Ultra - Violet</p> <p>L. 50 x p.47 x H.91</p>	TUV			
 <p>Elemento porta autoclave (precisare modello) 2 cassetti B - 2 fondi PVC 2 B - 2 PVC bottoms drawers housing unit for autoclave (specify the model) Elément pour autoclave encastrée (préciser le modèle) - 2 tiroirs B - 2 fonds en PVC</p> <p>L. 50 x p.47 x H.91</p>	TAU			
 <p>Elemento porta autoclave (larghezza 60) (precisare modello) 2 cassetti B - 2 fondi PVC 2 B - drawers housing unit for autoclave (specify the model) (width 60) - 2 PVC bottoms- Elément pour autoclave encastrée (préciser le modèle) (largeur 60) - 2 tiroirs B - 2 fonds en PVC</p> <p>L. 60 x p.47 x H.91</p>	TAU600			
 <p>Elemento 1 anta con frigorifero 1 door unit with refrigerator Elément 1 porte avec réfrigérateur</p> <p>L. 50 x p.47 x H.91</p>	TFRI			

DESCRIZIONE description	ARTICOLO article	EURO		
		laminato	vetro	corian
		laminar	glass	corian
laminé	verre	corian		
 <p>Elemento 1 anta per carrello C3R 1 door housing unit for C3R trolley Élément vide avec 1 porte pour un chariot C3R</p> <p>L. 50 x p.47 x H.91</p>	TCT			
<p>Carrello per mobile TCT Trolley for TCT element Chariot pour meuble TCT</p>				
 <p>Elemento portasciugamano Unit for towels Élément porte essuie-mains</p> <p>L. 25 x p.47 x H.91</p>	TASC			
 <p>Cassettiera 1 cassetto A sottopiano Drawer unit 1 A - drawer under shelf Tiroir A complet avec parois et glissières pour mettre sous plan</p> <p>L. 50 x p.47 x H.18,5</p>	CA1A			
 <p>Cassettiera 2 cassetti A sottopiano Drawer unit 2 A - drawers under shelf 2 Tiroirs A completi avec parois et glissières pour mettre sous plan</p> <p>L. 50 x p.47 x H.24,5</p>	CA2A			
 <p>Cassettiera 1 cassetto B sottopiano Drawer unit 1 B - drawer under shelf Tiroir B complet avec parois et glissières pour mettre sous plan</p> <p>L. 50 x p.47 x H.24,5</p>	CA1B			

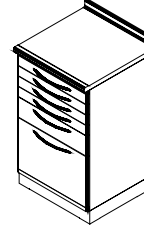
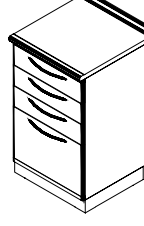

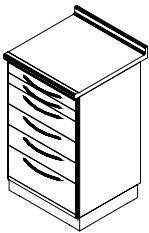
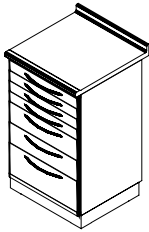
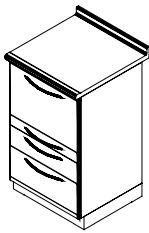
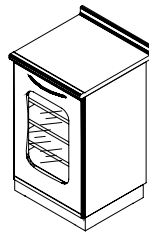
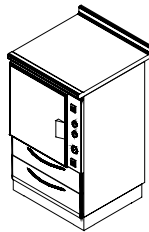
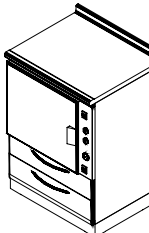
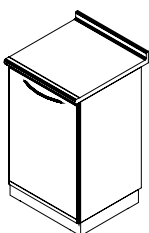
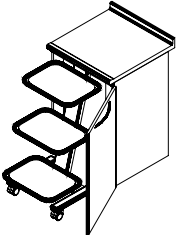
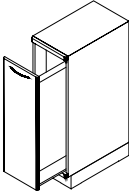
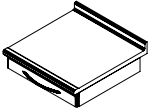
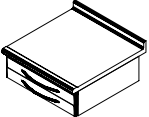
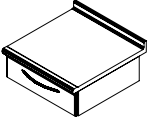
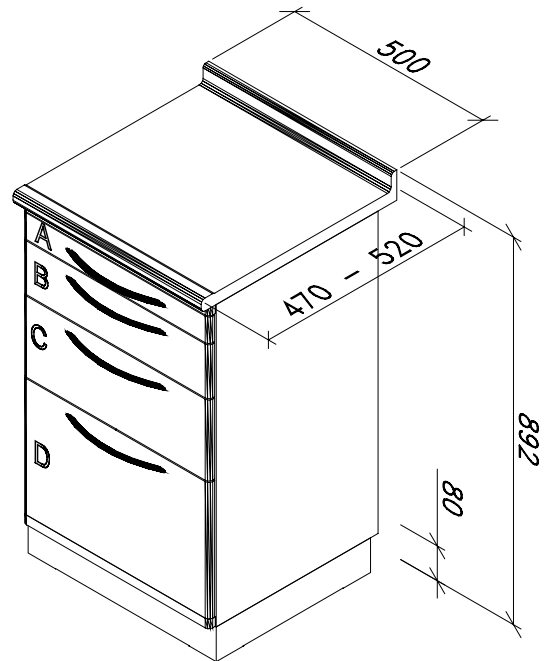
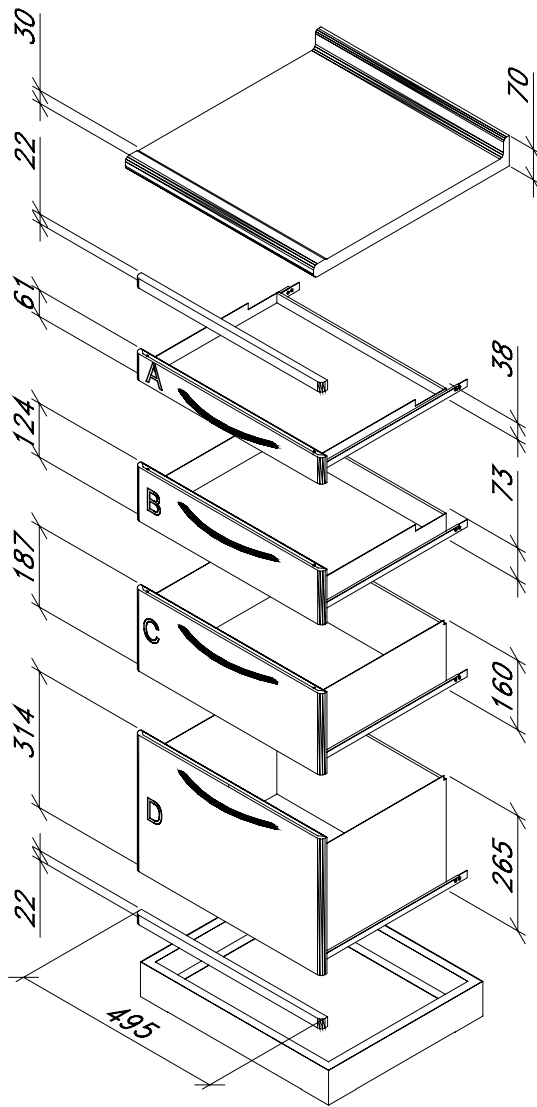
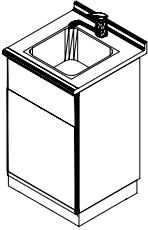
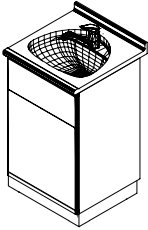
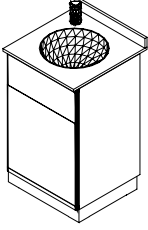
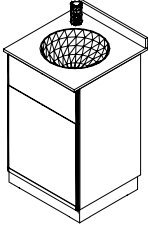
DESCRIZIONE description	ARTICOLO article	EURO
 <p>Elemento lavello con apertura ginocchio +vasca inox + miscelatore + portarifiuti Base unit for sink with bend opening +stainless steel sink + tap mixer + dustbin Elément lavabo avec porte ouverture au genou+vasque en inox + mélangeur + poubelle</p> <p>L. 50 x p.47 x H.91</p>	TL1	Piano laminato - vasca inox laminar top - inox sink plan laminé - vasque inox
	TL2	Piano vetro - vasca inox glass top - inox sink plan verre - vasque inox
 <p>Elemento lavello con apertura ginocchio +piano laminato+ vasca ceramica + miscelatore + portarifiuti Base unit for sink with bend opening+laminar top + ceramic sink + tap mixer + dustbin Elément lavabo avec porte ouverture au genou+plan en laminé+ vasque en ceramique + mélangeur + poubelle</p> <p>L. 50 x p.47 x H.91</p>	TLVC	
 <p>Elemento lavello con apertura ginocchio piano vetro + vasca vetro + miscelatore + portarifiuti Base unit for sink with bend opening glass top + glass sink + tap mixer - dustbin Elément lavabo avec porte ouverture au genou plan en verre + vasque en verre + mélangeur + poubelle</p> <p>L. 50 x p.47 x H.91</p>	TLVV	
 <p>Elemento lavello con apertura ginocchio piano corian + vasca corian + miscelatore + portarifiuti Base unit for sink with bend opening corian top + corian sink + tap mixer - dustbin Elément lavabo avec porte ouverture au genou plan en corian + vasque en corian + mélangeur + poubelle</p> <p>L. 50 x p.47 x H.91</p>	TLVCO	

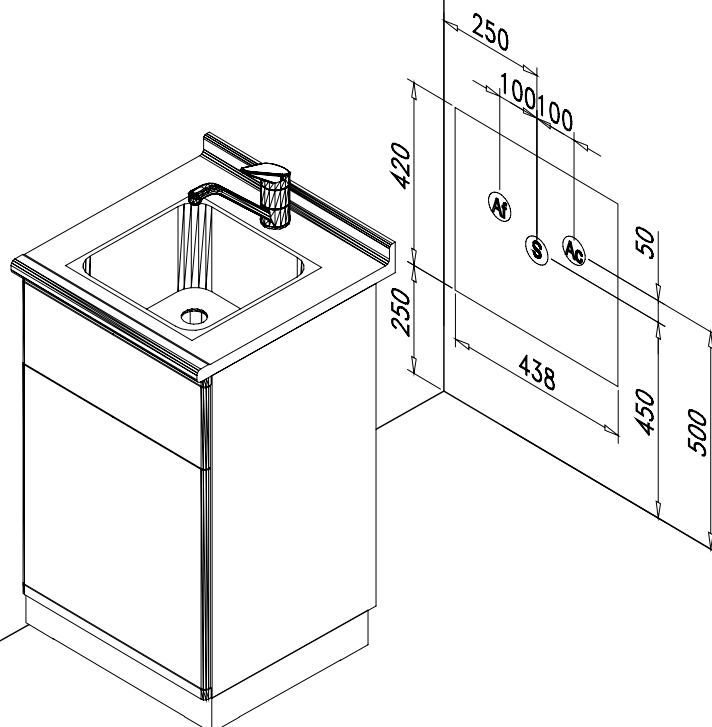

ELEMENTI FISSI SERIE AURORA - FIXED ELEMENTS AURORA SERIES - ELEMENTS FIXES SERIE AURORA

IL PREZZO E' COMPRESIVO DI PIANO - THE PRICE INCLUDES THE WORKTOP - DANS LE PRIX EST INCLUS LE PLAN

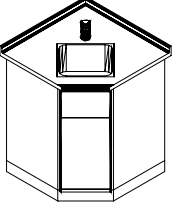
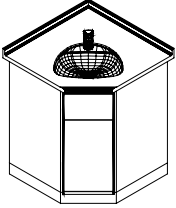
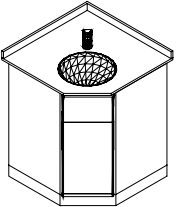
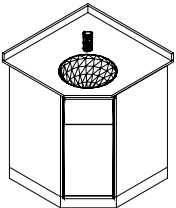
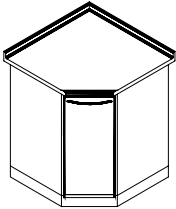
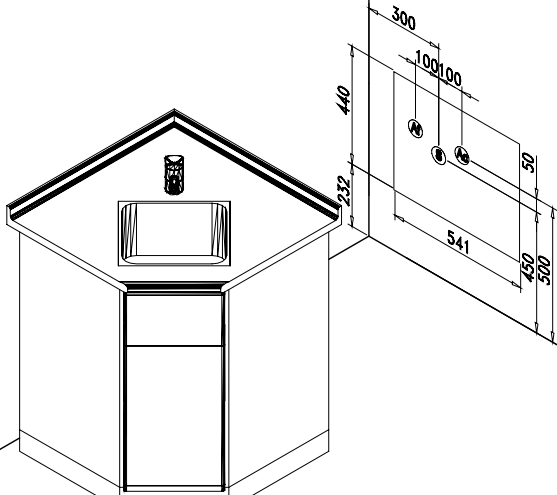
DESCRIZIONE description	ARTICOLO article	EURO
 <p>Elementoavello con apertura ginocchio + vasca inox + miscelatore + portarifiuti Corner base unit for sink with bend opening + stainless steel sink + tap mixer + dustbin Elément lavabo en angle avec porte ouverture au genou + vasque en inox + mélangeur + poubelle</p> <p>L. 66.5 x 66.5 x p.47 x H.91</p>	TLA1	Piano laminato - vasca inox laminar top - inox sink plan laminé - vasque inox
	TLA2	Piano vetro - vasca inox glass top - inox sink plan en verre - vasque inox
 <p>Elementoavello con apertura ginocchio+piano laminato+ vasca ceramica + miscelatore + portarifiuti Corner base unit for sink with bend opening +laminar top+ ceramic sink + tap mixer + dustbin Elément lavabo en angle avec porte ouverture au genou +plan en laminé+ vasque en ceramique + mélangeur + poubelle</p> <p>L. 66.5 x 66.5 x p.47 x H.91</p>	TLAVC	
 <p>Elementoavello angolare con apertura ginocchio piano vetro +vasca vetro + miscelatore + portarifiuti Corner base unit for sink with bend opening +glass top+ glass sink + mixer + dustbin Elément lavabo en angle avec porte ouverture au genou +plan en verre+ vasque en verre +mélangeur + poubelle</p> <p>L. 66.5 x 66.5 x p.47 x H.91</p>	TLAVV	
 <p>Elementoavello angolare con apertura ginocchio+piano in corian+vasca corian + miscelatore + portarifiuti Corner base unit for sink with bend opening +corian top+ corian sink + mixer + dustbin Elément lavabo en angle avec porte ouverture au genou +plan en corian+ vasque en corian +mélangeur + poubelle</p> <p>L. 66.5 x 66.5 x p.47 x H.91</p>	TLAVCO	
 <p>Elemento angolare 1 ripiano Corner base unit with 1 shelf Elément angulaire avec 1 rayon interne</p> <p>L. 66.5 x 66.5 x p.47 x H.91</p>	TA	
	TAV	
	TACO	
		

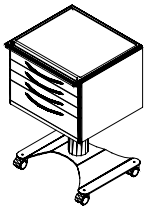
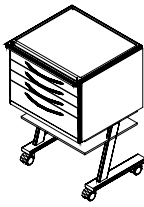
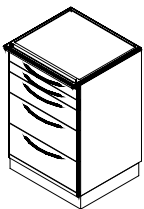
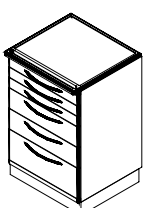
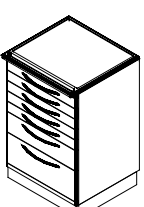
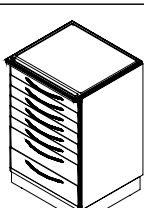
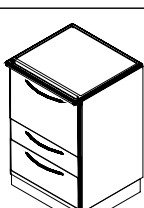
DESCRIZIONE description	ARTICOLO article	EURO		
		ceramica	vetro	corian
		ceramic	glass	corian
ceramique	verre	corian		
 <p>Elemento su carrello 3 cassetti A - 1 B 3 bacinelle - 1 fondo PVC Element on castors 3 A - drawers 1 B - drawers 3 trays -1 PVC bottom Elément mobile sur cart avec 3 tiroirs A - 1 B 3 intérieurs de tiroirs - 1 fond en PVC</p> <p>L. 50 x p.48 x H.79</p>	RC4Z			
 <p>Elemento su carrello 3 cassetti A - 1 B 3 bacinelle - 1 fondo PVC Element on castors 3 A - drawers 1 B - drawers 3 trays - 1 PVC bottom Elément mobile sur cart avec 3 tiroirs A - 1 B 3 intérieurs de tiroirs - 1 fond en PVC</p> <p>L. 50 x p.48 x H.79</p>	RC4			
 <p>Elemento 2 cassetti A - 1 B - 2 C 3 bacinelle - 2 fondi PVC 2 A - drawers 1 B - drawers 2 C - drawer unit 3 trays - 2 PVC bottoms Elément 2 tiroirs A - 1 B - 2C 3 intérieurs de tiroirs - 2 fonds en PVC</p> <p>L. 50 x p.48 x H.79</p>	RT5			
 <p>Elemento 3 cassetti A - 2 B - 1 C 5 bacinelle - 1 fondo in PVC 3 A - drawers 2 B - drawer 1 C - drawer unit 5 trays -1 PVC bottom Elément 3 tiroirs A - 2 B - 1C 5 intérieurs de tiroirs-1 fond en PVC</p> <p>L. 50 x p.48 x H.79</p>	RT6			
 <p>Elemento 5 cassetti A - 1 B - 1 C 5 bacinelle - 2 fondi PVC 5 A - drawers, 1 B -drawer 1 C drawer unit 5 trays -2 PVC bottom Elément 5 tiroirs A - 1 B - 1C 5 intérieurs de tiroirs-1 type 6 - 2 fonds en PVC</p> <p>L. 50 x p.48 x H.79</p>	RT7			
 <p>Elemento 6 cassetti A - 2 B 6 bacinelle -2 fondi PVC 6 A - drawers, 2 B -drawer 6 trays -2 PVC bottoms Elément 6 tiroirs A - 2 B 6 intérieurs de tiroirs - 2 fonds en PVC</p> <p>L. 50 x p.48 x H.79</p>	RT8			
 <p>Elemento 2 piani estraibili portastrumenti antina a scomparsa 1 cassetto B - 1 C 1 bacinella- 2 fondi in PVC Unit with 2 extractable surgical instruments holders disappearance door 1B drawer - 1 C drawer 1 tray - 2 PVC bottoms Elément 2 plans extractibles porte - instruments porte escamotable 1 tiroir B - 1 tiroir C-1 interieur de tiroirs -2 fonds en PVC</p> <p>L. 50 x p.48 x H.79</p>	RTEM2			

IL PREZZO E' COMPRESIVO DI PIANO - THE PRICE INCLUDES THE WORKTOP - DANS LE PRIX EST INCLUS LE PLAN

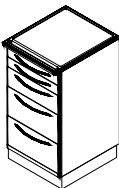
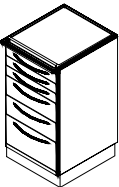
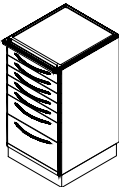
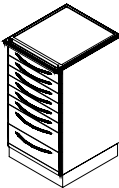
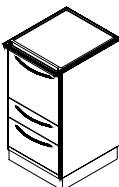
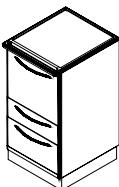
DESCRIZIONE description	ARTICOLO article	EURO		
		ceramica	vetro	corian
		ceramic	glass	corian
ceramique	verre	corian		
 <p>Elemento 2 cassetti A - 1 B - 2 C 2 A - drawers 1 B - drawers 2 C - drawer unit Elément 2 tiroirs A - 1 B - 2C</p> <p>L. 40 x p.48 x H.79</p>	SRT5			
 <p>Elemento 3 cassetti A - 2 B - 1 C 3 A - drawers 2 B - drawer 1 C - drawer unit Elément 3 tiroirs A - 2 B - 1 C</p> <p>L. 40 x p.48 x H.79</p>	SRT6			
 <p>Elemento 5 cassetti A - 1 B - 1 C 5 A - drawers, 1 B - drawer 1 C drawer unit Elément 5 tiroirs A - 1 B - 1C</p> <p>L. 40 x p.48 x H.79</p>	SRT7			
 <p>Elemento 6 cassetti A - 2 B 6 A- drawers, 2 B - drawers unit Elément 6 tiroirs A - 2 B</p> <p>L. 40 x p.48 x H.79</p>	SRT8			
 <p>Elemento 1 piano estraibile portastrumenti antina a scomparsa 1 cassetto B - 1C Unit with 1 extractable surgical instruments holder disappearance door 1 B - drawer, 1C drawer Elément 1 plan extractible porte - instruments porte escamotable</p> <p>L. 40 x p.48 x H.79</p>	SRTEM1			
 <p>Elemento 2 piani estraibili portastrumenti antina a scomparsa 1 cassetto B - 1C Unit with 2 extractable surgical instruments holder disappearance door 1 B - drawer, 1C drawer Elément 2 plans extractibles porte - instruments porte escamotable</p> <p>L. 40 x p.48 x H.79</p>	SRTEM2			

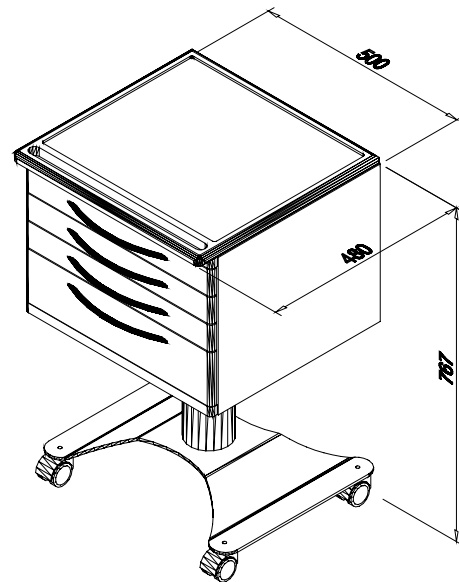
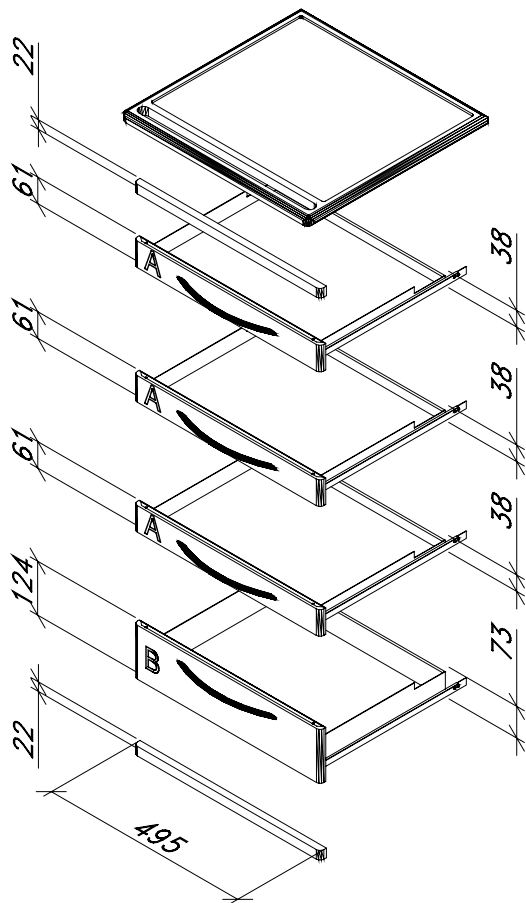

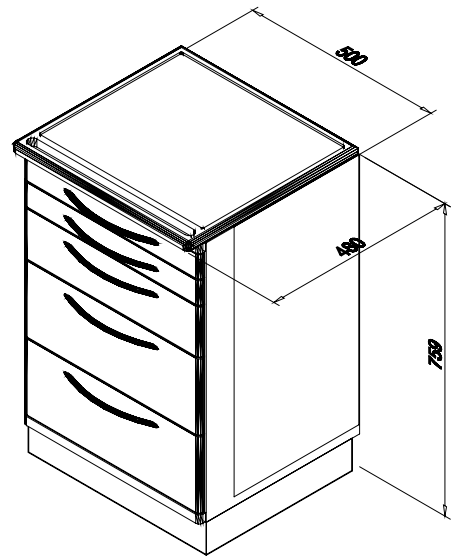
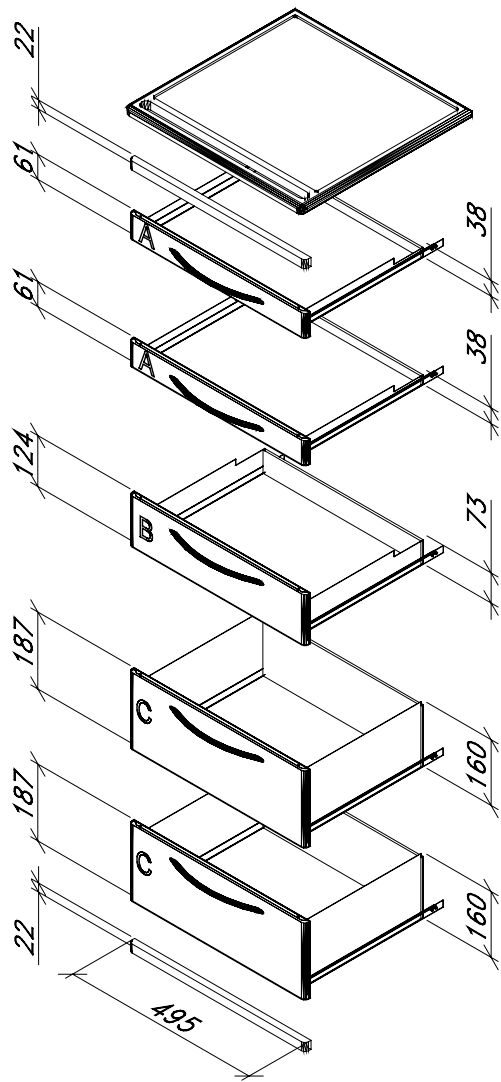

ELEMENTI FISSI SERIE PRESTIGE - FIXED ELEMENTS PRESTIGE SERIES - ELEMENTS FIXES SERIE PRESTIGE

IL PREZZO E' COMPRENSIVO DI PIANO - THE PRICE INCLUDES THE WORKTOP -DANS LE PRIX EST INCLUS LE PLAN

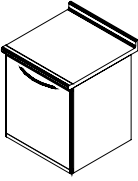
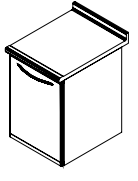
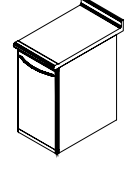
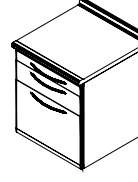
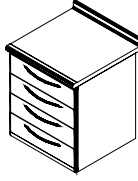
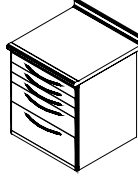
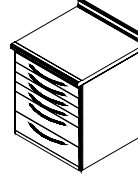
DESCRIZIONE description	ARTICOLO article	EURO		
		laminato	vetro	corian
		laminar	glass	corian
laminé	verre	corian		
 <p>Elemento 1 anta - 1 ripiano 1 door cabinet - 1 shelf Elément 1 porte - 1 rayon interne</p> <p>L. 50 x p.47 x H.62,5</p>	PT			
 <p>Elemento 1 anta - 1 ripiano (larghezza 40) 1 door cabinet - 1 shelf (width 40) Elément 1 porte - 1 rayon interne (largeur 40)</p> <p>L. 40 x p.47 x H.62,5</p>	PT400			
 <p>Elemento 1 anta - 1 ripiano (larghezza 30) 1 door cabinet - 1 shelf (width 30) Elément 1 porte - 1 rayon interne (largeur 30)</p> <p>L. 30 x p.47 x H.62,5</p>	PT300			
 <p>Elemento 1 cassetto A 1 - 1 B - 1 D 2 bacinelle- 1 fondo PVC 1 A drawer - 1 B drawer - 1 D drawer 2 trays - 1 PVC bottom Elément 1 tiroir A - 1 tiroir B - 1 tiroir D 2 intérieurs de tiroirs - 1fond en PVC</p> <p>L. 50 x p.47 x H.62,5</p>	PT3			
 <p>Elemento 4 cassetti B 2 bacinelle- 2 fondi PVC 4 B drawers unit 2 trays - 2 PVC bottoms Elément 4 tiroirs B 2 intérieurs de tiroirs - 2 fonds en PVC</p> <p>L. 50 x p.47 x H.62,5</p>	PT4			
 <p>Elemento 3 cassetti A - 1 B - 1 C 4 bacinelle - 1 fondo PVC 3 A drawers - 1 B drawer - 1 C drawer 4 trays type 2 - 1 PVC bottom Elément 3 tiroirs A - 1 tiroir B - 1 tiroir C 4 intérieurs de tiroirs -1fond en PVC</p> <p>L. 50 x p.47 x H.62,5</p>	PT5			
 <p>Elemento 4 cassetti A - 2 B 4 bacinelle - 2 fondi PVC 4 A drawers - 2 B drawers 4 trays - 2 PVC bottoms Elément 4 tiroirs A - 2 tiroirs B 4 intérieurs de tiroirs - 2 fonds en PVC</p> <p>L. 50 x p.47 x H.62,5</p>	PT6			

ELEMENTI FISSI SERIE PRESTIGE - FIXED ELEMENTS PRESTIGE SERIES - ELEMENTS FIXES SERIE PRESTIGE

IL PREZZO E' COMPRESIVO DI PIANO - THE PRICE INCLUDES THE WORKTOP - DANS LE PRIX EST INCLUS LE PLAN

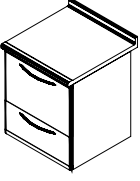
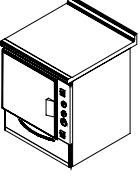
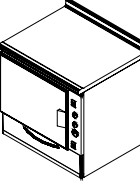
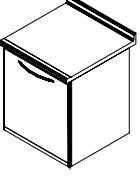
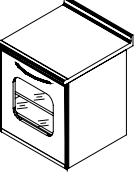
DESCRIZIONE description	ARTICOLO article	EURO		
		laminato	vetro	corian
		laminar	glass	corian
		laminé	verre	corian
 <p>Elemento 2 piani estraibili portastrumenti antina a scomparsa 1 cassetto C con un fondo PVC Unit with 2 extractable surgical instruments holders disappearance door - 1 C drawer with one PVC bottom Elément 2 plans extractibles porte-instruments porte escamotable- 1 tiroir C avec un fond en PVC</p> <p>L. 50 x p.47 x H.62,5</p>	PTEM2			
 <p>Elemento porta autoclave (specificare il modello) 1 cassetto B con 1 fondo PVC 1B drawer housing unit for autoclave (specify the model) with one PVC bottom Elément pour autoclave encastrée (préciser le model) 1 tiroir B avec un fond en PVC</p> <p>L. 50 x p.47 x H.62,5</p>	PTAU			
 <p>Elemento porta autoclave (specificare il modello) 1 cassetto B con 1 fondo PVC (larghezza 60) 1B drawer housing unit for autoclave (specify the model) with one PVC bottom (width 60) Elément pour autoclave encastrée (préciser le model) 1 tiroir B avec un fond en PVC (largeur 60)</p> <p>L. 60 x p.47 x H.62,5</p>	PTAU600			
 <p>Elemento 1 anta con frigorifero 1 door unit with refrigerator Elément 1 porte avec réfrigérateur</p> <p>L. 60 x p.47 x H.62,5</p>	PTFRIG			
 <p>Elemento 1 antina-5 ripiani lamiera forata lampada ultravioletti 1 door-5 perforated plate shelves unit U.V. lamp Elément 1 porte-5 rayons en métal perforée lampe Ultra-Violet</p> <p>L. 60 x p.47 x H.62,5</p>	PTUV			

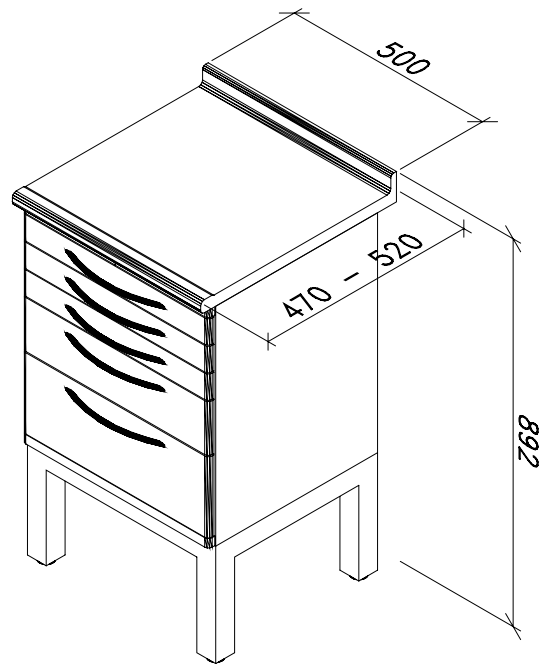
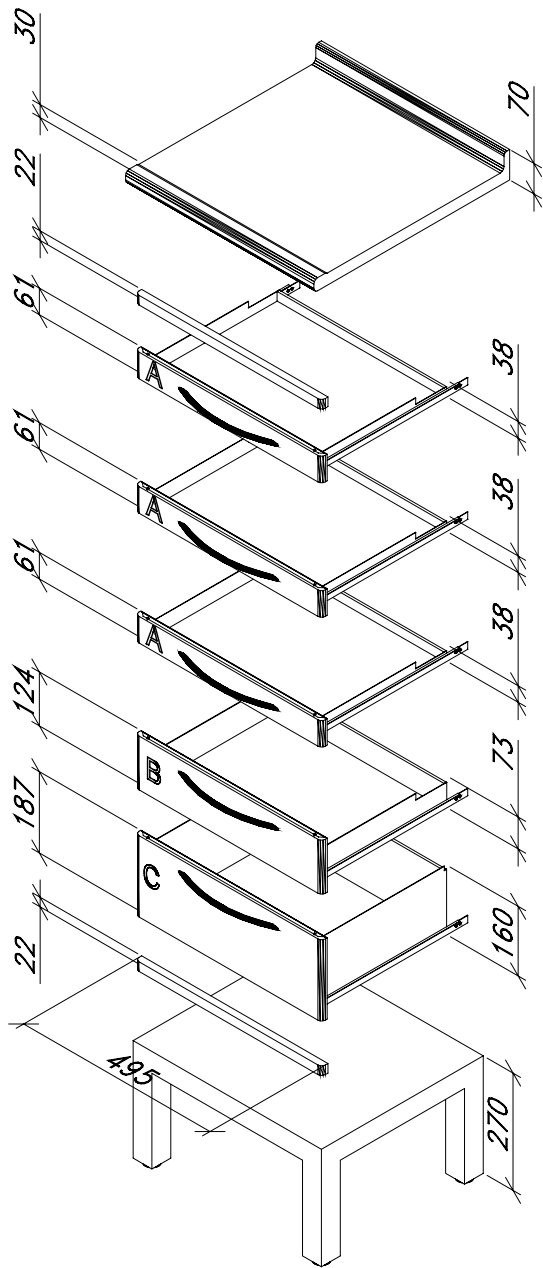

ELEMENTI FISSI SERIE PRESTIGE - FIXED ELEMENTS PRESTIGE SERIES - ELEMENTS FIXES SERIE PRESTIGE

IL PREZZO E' COMPRESIVO DI PIANO - THE PRICE INCLUDES THE WORKTOP - DANS LE PRIX EST INCLUS LE PLANT LE PLAN

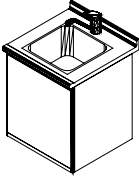
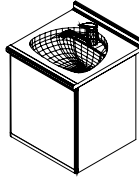
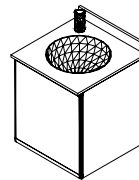
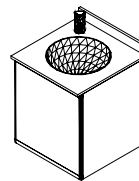
<p>NB: LE COMPOSIZIONI SONO COMPLETE DI SUPPORTO H.28 CM IN ACCIAIO THE COMPOSITIONS ARE COMPLETED OF SUPPORT H.28 CM IN STAINLESS STEEL LES COMPOSITIONS SE MONTENT SUR UNE BASE METALIQUE DE 28 CM DE HAUTEUR</p>	<p>ARTICOLO article</p>	<p>EURO</p>
 <p>Elementoavello con apertura ginocchio +vasca inox+miscelatore +portarifiuti Base unit for sink with bend opening+stainless steel sink+tap mixer+dustbin Elément lavabo avec porte ouverture au genou en +vasque en inox+mélangeur+poubelle</p> <p>L. 50 x p.47 x H.62,5</p>	<p>PTL1</p>	<p>Piano laminato- vasca inox laminar top- inox sink plan laminè -vasque inox</p>
<p>PTL2</p>	<p>Piano vetro- vasca inox glass top- inox sink plan verre -vasque inox</p>	
 <p>Elementoavello con apertura ginocchio+piano laminato+vasca ceramica+miscelatore +portarifiuti Base unit for sink with bend opening+laminated top+ceramic sink +tap mixer+dustbin Elément lavabo avec porteouverture au genou+plan en laminè+vasque en ceramique+mélangeur+poubelle</p> <p>L. 50 x p.47 x H.62,5</p>	<p>PTLVC</p>	
 <p>Elementoavello con apertura ginocchio+piano vetro+vasca vetro+miscelatore +portarifiuti Base unit for sink with bend opening+glass top+glass sink +tap mixer+dustbin Elément lavabo avec porteouverture au genou+plan en verre+vasque en verre+mélangeur+poubelle</p> <p>L. 50 x p.47 x H.62,5</p>	<p>PTLVV</p>	
 <p>Elementoavello con apertura ginocchio+piano corian+vasca corian+miscelatore +portarifiuti Base unit for sink with bend opening+corian top+corian sink +tap mixer+dustbin Elément lavabo avec porteouverture au genou+plan en corian+vasque en corian+mélangeur+poubelle</p> <p>L. 50 x p.47 x H.62,5</p>	<p>PTLVCO</p>	

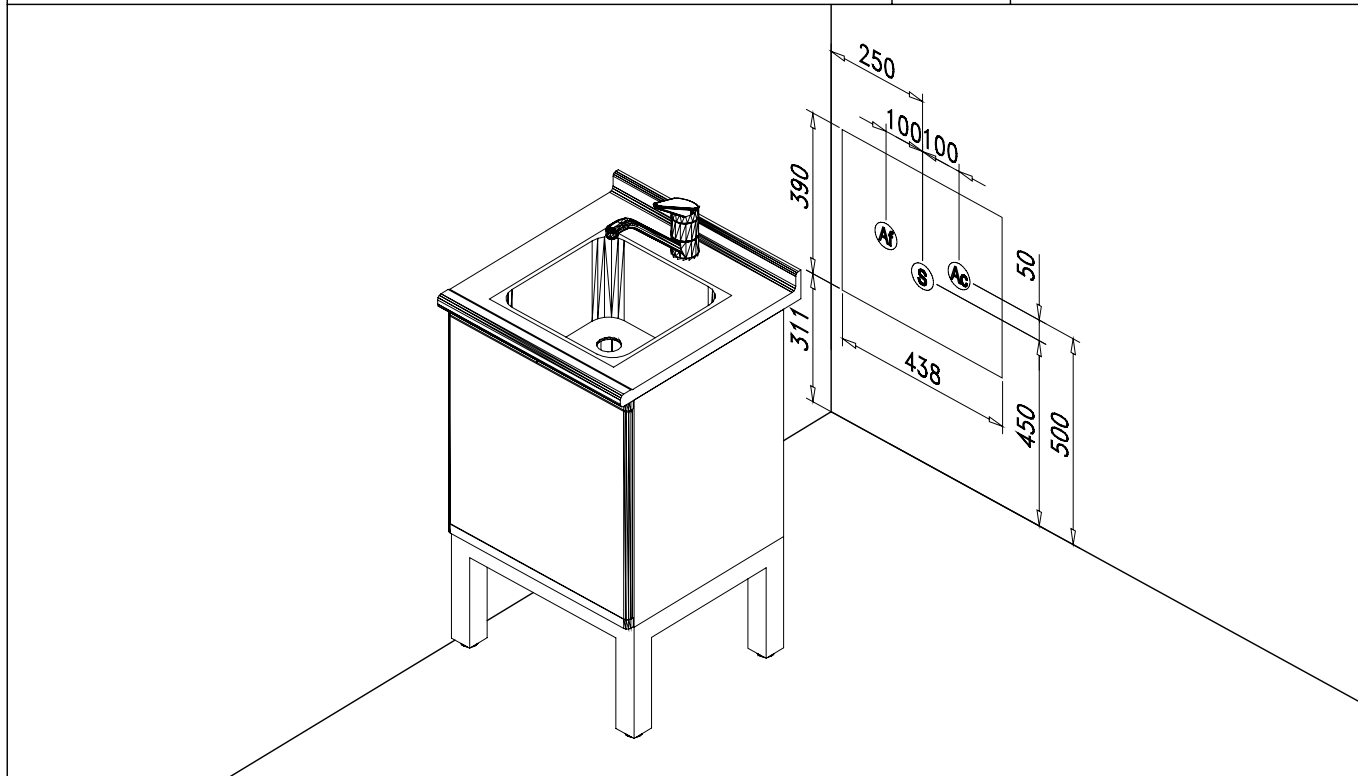

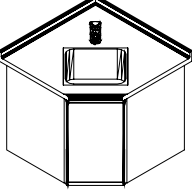
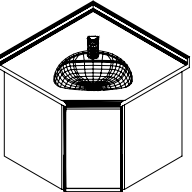
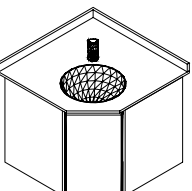
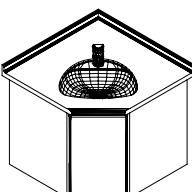
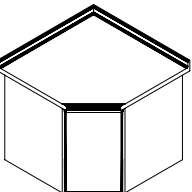

ELEMENTI FISSI SERIE PRESTIGE - FIXED ELEMENTS PRESTIGE SERIES - ELEMENTS FIXES SERIE PRESTIGE

IL PREZZO E' COMPRESIVO DI PIANO - THE PRICE INCLUDES THE WORKTOP -DANS LE PRIX EST INCLUS LE PLAN

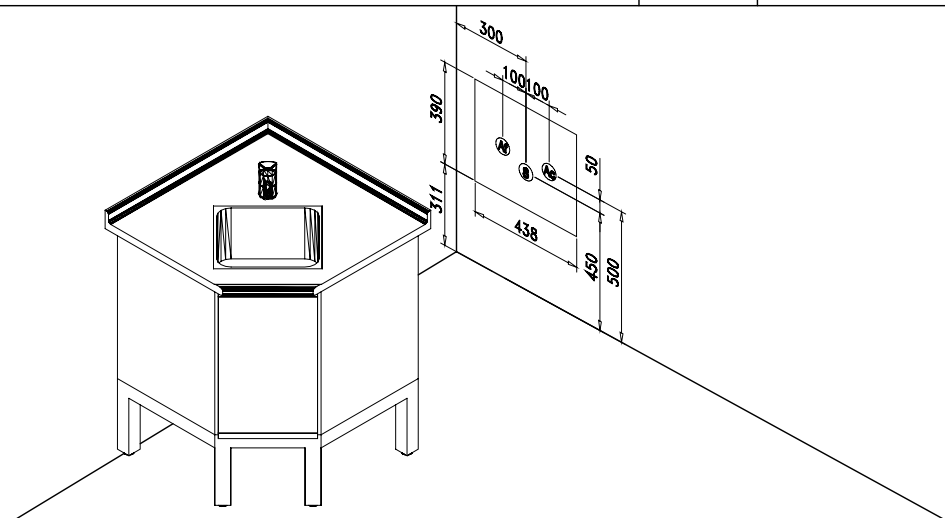

DESCRIZIONE description	ARTICOLO article	EURO
 <p>Elementoavello angolare con apertura ginocchio+vasca inox+miscelatore+portarifiuti Corner base unit for sink with bend opening+stainless steel sink+tap mixer+dustbin Elément lavabo en angleavec porte ouverture au genou+vasque inox+mélangeur+poubelle</p> <p>L.66,5 x 66,5 x p.47 x H.62,5</p>	PTLA1	Piano laminato- vasca inox laminar top- inox sink plan laminè -vasque inox
	PTLA2	Piano vetro-vasca inox glass top inox sink plan verre-vasque inox
 <p>Elementoavello angolare conapertura ginocchio +piano laminato+vasca ceramica+miscelatore+portarifiuti Corner base unit for sink with bend opening+laminar top+ceramic sink+tap mixer+dustbin Elément lavabo en angleavec porte ouverture au genou+plan en laminè+vasque en ceramic+mélangeur+poubelle</p> <p>L.66,5 x 66,5 x p.47 x H.62,5</p>	PTLAVC	
 <p>Elementoavello angolare conapertura ginocchio +piano vetro+vasca vetro+miscelatore+portarifiuti Corner base unit for sink with bend opening+glass top+glass sink+tap mixer+dustbin Elément lavabo en angleavec porte ouverture au genou+plan en verre+vasque verre+mélangeur+poubelle</p> <p>L.66,5 x 66,5 x p.47 x H.62,5</p>	PTLAVV	
 <p>Elementoavello angolare conapertura ginocchio +piano corian+vasca corian+miscelatore+portarifiuti Corner base unit for sink with bend opening+corian top+corian sink+tap mixer+dustbin Elément lavabo en angleavec porte ouverture au genou+plan en corian+vasque en corian+mélangeur+poubelle</p> <p>L.66,5 x 66,5 x p.47 x H.62,5</p>	PTLAVCO	
 <p>Elemento angolare con 1 ripiano Corner base unit with 1 shelf Elément angulaire avec 1 rayon interne</p> <p>L.66,5 x 66,5 x p.47 x H.62,5</p>	PTA	
	PTAV	
	PTACO	

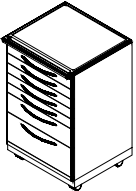
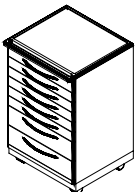
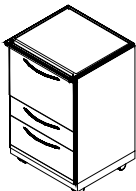

IL PREZZO E' COMPRESIVO DI PIANO - THE PRICE INCLUDES THE WORKTOP - DANS LE PRIX EST INCLUS LE PLAN

DESCRIZIONE description	ARTICOLO article	EURO		
		ceramica	vetro	corian
		ceramic	glass	corian
ceramique	verre	corian		
 <p>Elemento 2 cassetti A - 1 B - 2 C 3 bacinelle - 2 fondi PVC 2 A - drawers 1 B - drawer - 2 C - drawers unit 3 trays - 2 PVC bottoms Elément 2 tiroirs A - 1 B - 2C 3 intérieurs de tiroirs- 2 fonds en PVC</p> <p>L. 50 x p.48 x H.79</p>	PRT5			
 <p>Elemento 3 cassetti A - 2 B - 1 C 4 bacinelle -2 fondi PVC 3 A - drawers 2 B - drawer 1 C - drawer unit 4 trays - 2PVC bottoms Elément 3 tiroirs A - 2 B - 1C 4 intérieurs de tiroirs-2 fonds en PVC</p> <p>L. 50 x p.48 x H.79</p>	PRT6			
 <p>Elemento 5 cassetti A - 1 B - 1 C 5 bacinelle - 2 fondo PVC 5 A - drawers, 1 B -drawer 1 C drawer unit 5 trays -2 PVC bottoms Elément 5 tiroirs A - 1 B - 1C 5 intérieurs de tiroirs-2 fonds en PVC</p> <p>L. 50 x p.48 x H.79</p>	PRT7			
 <p>Elemento 6 cassetti A - 2 B 5 bacinelle - 3 fondi PVC 6 A - drawers, 2 B -drawer unit 5 tray -3 PVC bottoms Elément 6 tiroirs A - 2 B 5 intérieurs de tiroirs- 3 fonds en PVC</p> <p>L. 50 x p.48 x H.79</p>	PRT8			
 <p>Elemento 2 piani estraibili portastrumenti antina a scomparsa - 1 cassetto B - 1C 1 bacinella- 1 fondo PVC Unit with 2 extractables surgical instruments holders disappearance door 1B drawer-1C 1 tray- 1 PVC bottom Elément 2 plans extractibles porte-instruments porte escamotable 1 tiroir B- 1C 1 interieur de tiroirs: - 1 fond en PVC</p> <p>L. 50 x p.48 x H.79</p>	PRTEM2			

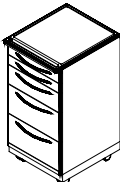
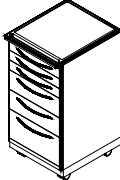
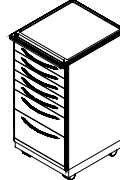
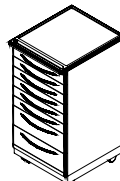
IL PREZZO E' COMPRESIVO DI PIANO - THE PRICE INCLUDES THE WORKTOP -DANS LE PRIX EST INCLUS LE PLAN

DESCRIZIONE description	ARTICOLO article	EURO		
		ceramica	vetro	corian
		ceramic	glass	corian
ceramique	verre	corian		
 <p>Elemento 2 cassetti A - 1 B - 2 C 2 A - drawers 1 B - drawers 2 C - drawer unit Elément 2 tiroirs A - 1 B - 2C</p> <p>L. 40 x p.48 x H.79</p>	PSRT5			
 <p>Elemento 3 cassetti A - 2 B - 1 C 3 A - drawers 2 B - drawer 1 C - drawer unit Elément 3 tiroirs A - 2 B - 1C</p> <p>L. 40 x p.48 x H.79</p>	PSRT6			
 <p>Elemento 5 cassetti A - 1 B - 1 C 5 A - drawers, 1 B - drawer 1 C drawer unit Elément 5 tiroirs A - 1 B - 1C</p> <p>L. 40 x p.48 x H.79</p>	PSRT7			
 <p>Elemento 6 cassetti A - 2 B 6 A- drawers, 2 B - drawers unit Elément 6 tiroirs A - 2 B</p> <p>L. 40 x p.48 x H.79</p>	PSRT8			
 <p>Elemento 1 piano estraibile portastrumenti antina a scomparsa 1 cassetto B - 1C Unit with 1 extractable surgical instruments holder disappearance door 1 B - drawer, 1C drawer Elément 1 plan extractible porte - instruments porte escamotable 1 tiroir B- 1 C</p> <p>L. 40 x p.48 x H.79</p>	PSRTEM1			
 <p>Elemento 2 piani estraibili portastrumenti antina a scomparsa 1 cassetto B - 1C Unit with 2 extractable surgical instruments holder disappearance door 1 B - drawer, 1C drawer Elément 2 plans extractibles porte - instruments porte escamotable 1 tiroir B - 1 C</p> <p>L. 40 x p.48 x H.79</p>	PSRTEM2			

ELEMENTI FISSI SERIE ELITE - FIXED ELEMENTS ELITE SERIES - ELEMENTS FIXES SERIE ELITE

IL PREZZO E' COMPRESIVO DI PIANO - THE PRICE INCLUDES THE WORKTOP -DANS LE PRIX EST INCLUS LE PLAN

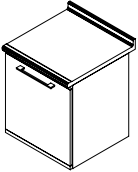
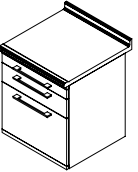
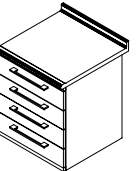
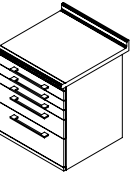
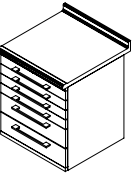
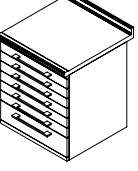
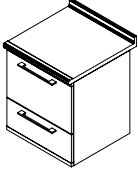
DESCRIZIONE description	ARTICOLO article	EURO		
		laminato	vetro	corian
		laminar	glass	corian
		laminé	verre	corian
<p>NB: MOBILI DOTATI DI GUIDE CON RIENTRO AUTOMATICO ELEMENTS WITH SELF - CLOSING SYSTEM OF DRAWERS ELEMENTS AVEC SYSTEME AUTOMATIQUE DE GLISSIERES</p>  <p>Elemento un anta - 2 ripiani 1 door unit- 2 shelves Elément 1 porte - 2 rayons internes</p> <p>L. 50 x p.47 x H.62,5</p>	ET			
 <p>Elemento 1 cassetto A-1 B- 1 D 2 bacinelle - 1 fondo PVC 1 A drawer - 1 B drawer - 1 D drawer 2 trays- 1 PVC bottom Elément 1 tiroir A- 1B- 1 D 2 intérieurs de tiroir - 1 fond en PVC</p> <p>L. 50 x p.47 x H.62,5</p>	ET3			
 <p>Elemento 4 B 2 bacinelle- 2fondi in PVC 4 B drawers 2 trays- 2 PVC bottoms Elément 4 tiroirs B 2 intérieurs de tiroirs- 2 fonds en PVC</p> <p>L. 50 x p.47 x H.62,5</p>	ET4			
 <p>Elemento 3 cassetti A- 1 B - 1C 4 bacinelle - 1 fondo PVC 3 Adrawers- 1B- 1 C 4 trays 5- 1 PVC bottom Elément 3 tiroirs A- 1 B- 1C 4 intérieurs de tiroirs- 1 fond en PVC</p> <p>L. 50 x p.47 x H.62,5</p>	ET5			
 <p>Elemento 4 cassetti A - 2 B 4 bacinelle - 2 fondi PVC 4 A drawers- 2B 4trays - 2 PVC bottoms Elément 4 tiroirs A- 2 B 4 intérieurs de tiroirs- 2 fonds en PVC</p> <p>L. 50 x p.47 x H.62,5</p>	ET6			
 <p>Elemento 6 cassetti A - 1 B 5 bacinelle- 2 fondi PVC 6 A drawers- 1 B 5 trays- 2 with PVC bottom Elément 6 tiroirs A - 1B 5 intérieurs de tiroirs-2 fonds en PVC</p> <p>L. 50 x p.47 x H.62,5</p>	ET7			
 <p>Elemento 2 piani estraibili portastrumenti antina a scomparsa 1 cassetto A - 1B 1 bacinella - 1 fondo PVC Unit with 2 movable surgical instruments holders disappearance door 1 A drawer- 1B 1 tray - 1 PVC bottom Elément 2 plans extractable porte-instruments porte escamotable 1 tiroir A-1B-1 intérieur de tiroir - 1 fond en PVC</p> <p>L. 50 x p.47 x H.62,5</p>	ETEM2			

ELEMENTI FISSI SERIE ELITE - FIXED ELEMENTS ELITE SERIES - ELEMENTS FIXES SERIE ELITE

IL PREZZO E' COMPRESIVO DI PIANO - THE PRICE INCLUDES THE WORKTOP - DANS LE PRIX EST INCLUS LE PLAN

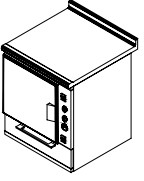
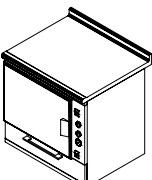
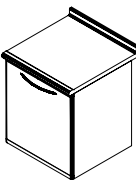
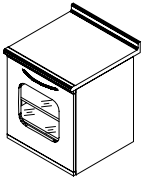
DESCRIZIONE description	ARTICOLO article	EURO		
		laminato	vetro	corian
		laminar	glass	corian
		laminé	verre	corian
 <p>Elemento porta autoclave (precisare modello) 1 cassetti B- 2 fondo PVC 1 B- 1 PVC bottom housing unit for autoclave (specify the model) Elément pour autoclave encastrée (préciser le modèle) 1 tiroir B- 1 fond en PVC</p> <p>L. 50 x p.47 x H.62,5</p>	ETAU			
 <p>Elemento porta autoclave-larghezza 600 (precisare modello) 1 cassetti B-1 fondo PVC 1 B- 1PVC bottom housing unit for autoclave -width 600(specify the model) Elément pour autoclave encastrée-largeur 600 (préciser le modèle) 1 tiroir B- 1 fond en PVC</p> <p>L. 50 x p.47 x H.62,5</p>	ETAU600			
 <p>Elemento 1 anta con frigorifero 1 door unit with refrigerator Elément 1 porte avec réfrigérateur</p> <p>L. 50 x p.47 x H.62,5</p>	ETFRIG			
 <p>Elemento 1 antina-5 ripiani lamiera forata lampada ultravioletti 1 door- 5 perfored plates shelves unit U.V. lamp Elément 1 porte- 5 rayons en métal perforée-lampe Ultra Violet</p> <p>L. 50 x p.47 x H.62,5</p>	ETUV			

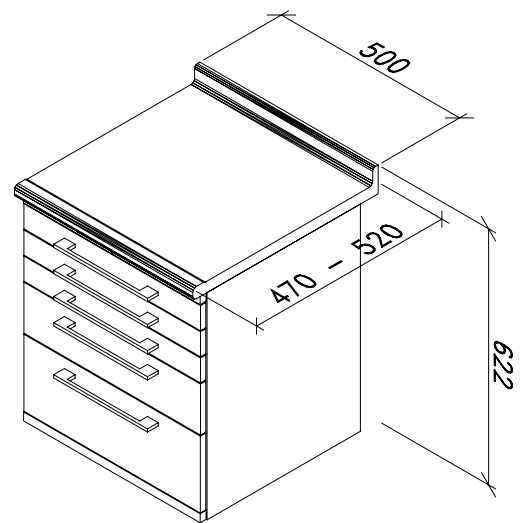
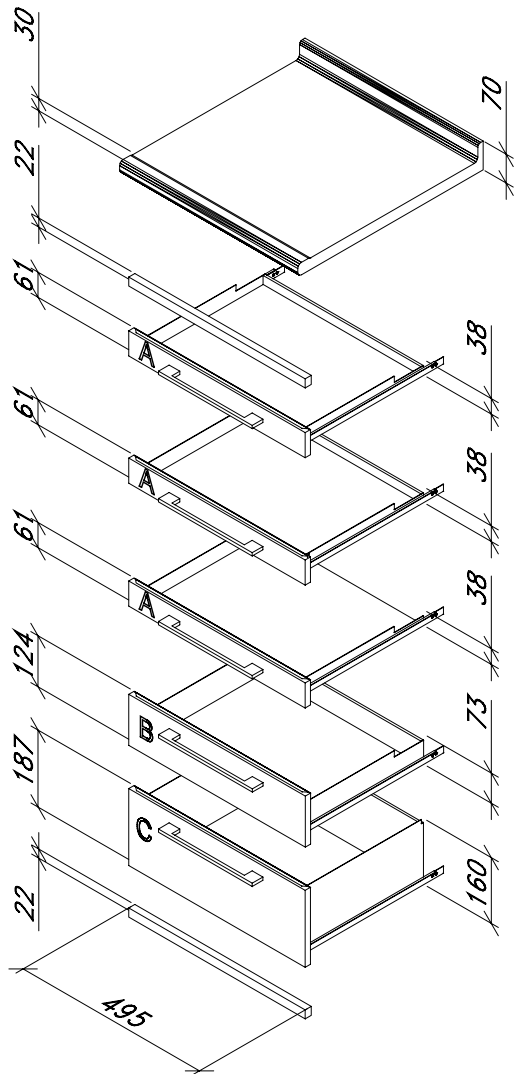

ELEMENTI FISSI SERIE ELITE- FIXED ELEMENTS ELITE SERIES - ELEMENTS FIXES SERIE ELITE

IL PREZZO E' COMPRESIVO DI PIANO - THE PRICE INCLUDES THE WORKTOP - DANS LE PRIX EST INCLUS LE PLAN

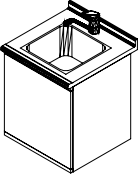
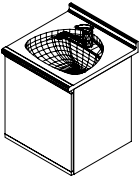
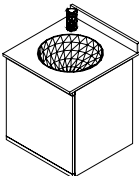
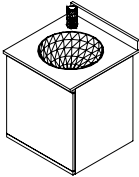
DESCRIZIONE description	ARTICOLO article	EURO
 <p>Elemento lavello con apertura ginocchio +piano laminato+ vasca inox + miscelatore + portarifiuti Base unit for sink with bend opening+stainless steel sink- tap mixer+dustbin Elément lavabo avec porte ouverture au genou+vasque en inox- mélangeur+poubelle</p> <p>L. 50 x p.47 x H.62,5</p>	ETL1	Piano laminato - vasca inox laminar top - inox sink plan laminé - vasque inox
	ETL2	Piano vetro - vasca inox glass top - inox sink plan verre - vasque inox
 <p>Elemento lavello con apertura ginocchio + piano laminato + vasca ceramica + miscelatore + portarifiuti Base unit for sink with bend opening+laminar top+ceramic sink- tap mixer+dustbin Elément lavabo avec porte ouverture au genou+plan en laminé+vasque en ceramique- mélangeur+poubelle</p> <p>L. 50 x p.47 x H.62,5</p>	ETLVC	
 <p>Elemento lavello con apertura ginocchio + piano vetro + vasca vetro + miscelatore + portarifiuti Base unit for sink with bend opening + glass top + glass sink- tap mixer+dustbin Elément lavabo avec porte ouverture au genou+plan en verre + vasque en verre- mélangeur+poubelle</p> <p>L. 50 x p.47 x H.62,5</p>	ETLVV	
 <p>Elemento lavello con apertura ginocchio + piano corian + vasca corian + miscelatore + portarifiuti Base unit for sink with bend opening+corian top+corian sink- tap mixer+dustbin Elément lavabo avec porte ouverture au genou+plan en corian+vasque en corian+ mélangeur+poubelle</p> <p>L. 50 x p.47 x H.62,5</p>	ETLVCO	

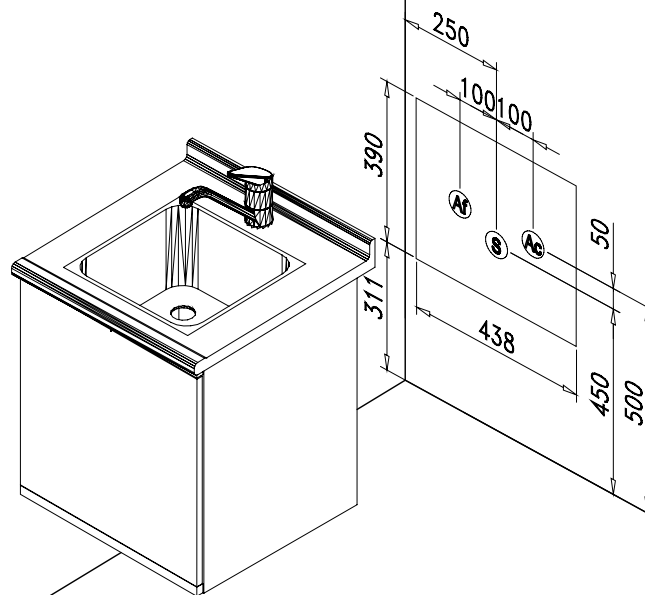



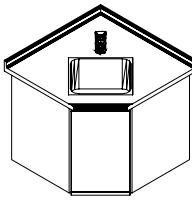
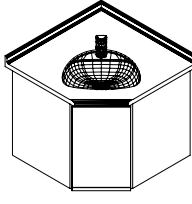
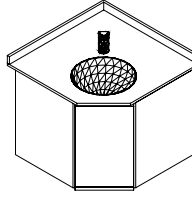
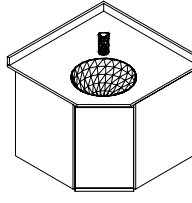
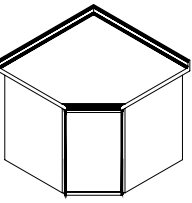

ELEMENTI FISSI SERIE ELITE - FIXED ELEMENTS ELITE SERIES - ELEMENTS FIXES SERIE ELITE

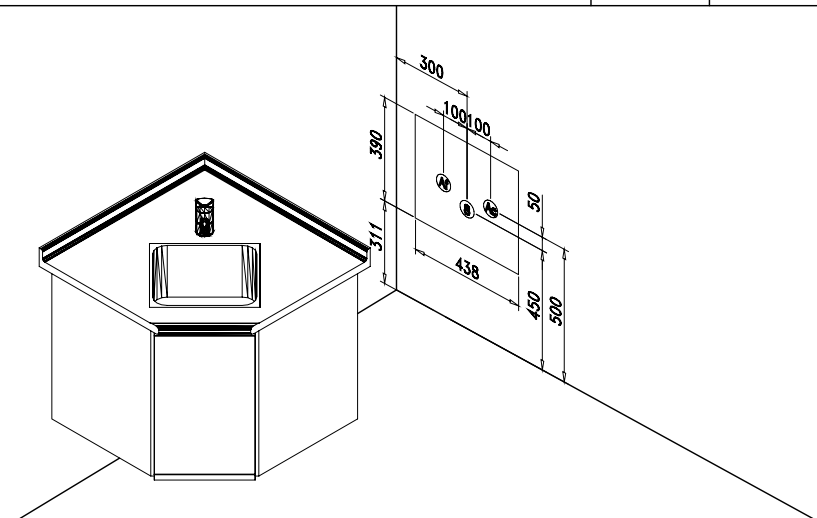
IL PREZZO E' COMPRESIVO DI PIANO - THE PRICE INCLUDES THE WORKTOP - DANS LE PRIX EST INCLUS LE PLAN

DESCRIZIONE description	ARTICOLO article	EURO
 <p>Elemento lavello con apertura ginocchio+vasca inox+miscelatore+ portarifiuti Corner base unit for sink with bend opening+stainless steel sink+tap mixer+dustbin Elément lavabo en angle avec porte ouverture au genou+vasque en inox+mélangeur+poubelle</p> <p>L.66,5 x 66,5 x p.47 x H.62,5</p>	ETLA1	Piano laminato - vasca inox laminar top - inox sink plan laminé - vasque inox
	ETLA2	Piano vetro - vasca inox glass top - inox sink plan verre - vasque inox
 <p>Elemento lavello con apertura ginocchio+piano laminato+vasca ceramica+miscelatore+ portarifiuti Corner base unit for sink with bend opening+ laminar worktop+ceramic sink+tap mixer+dustbin Elément lavabo en angle avec porte ouverture au genou+plan en laminé+vasque en ceramique+mélangeur+poubelle</p> <p>L.66,5 x 66,5 x p.47 x H.62,5</p>	ETLAVC	
 <p>Elemento lavello con apertura ginocchio+vasca vetro+miscelatore+ portarifiuti Corner base unit for sink with bend opening+glass sink+tap mixer+dustbin Elément lavabo en angle avec porte ouverture au genou vasque en verre+mélangeur+poubelle</p> <p>L.66,5 x 66,5 x p.47 x H.62,5</p>	ETLAVV	
 <p>Elemento lavello con apertura ginocchio+vasca corian+miscelatore+ portarifiuti Corner base unit for sink with bend opening+corian sink+tap mixer+dustbin Elément lavabo en angle avec porte ouverture au genou+plan en corian+vasque en corian+mélangeur+poubelle</p> <p>L.66,5 x 66,5 x p.47 x H.62,5</p>	ETLVCO	
 <p>Elemento angolare un ripiano Corner base unit with 1 shelf Elément angulaire avec 1 rayon interne</p> <p>L.66,5 x 66,5 x p.47 x H.62,5</p>	ETA	
	ETAV	
	ETACO	

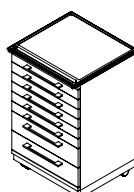

DESCRIZIONE description	ARTICOLO article	EURO		
		ceramica	vetro	corian
		ceramic	glass	corian
<p>NB: MOBILI DOTATI DI GUIDE CON RIENTRO AUTOMATICO ELEMENTS WITH SELF - CLOSING SYSTEM OF DRAWERS SYSTEME AUTOMATIQUE DE GLISSIERE</p>				
 <p>Elemento 2 cassetti A - 1 B - 2 C 3 bacinelle - 2 fondi PVC 2 A - drawers 1 B - drawers 2 C - drawer unit + self-closing system 3 trays -2 PVC bottoms Elément 2 tiroirs A - 1 B - 2C + système automatique de glissière 3 intérieurs de tiroirs: - 2 fonds en PVC</p> <p>L. 50 x p.48 x H.79</p>	ERT5			
 <p>Elemento 3 cassetti A - 2 B - 1 C 5 bacinelle -1 fondo PVC 3 A - drawers 2 B - drawer 1 C - drawer unit 5 trays - 1 PVC bottom Elément 3 tiroirs A - 2 B - 1C 5 intérieurs de tiroirs -1 fond en PVC</p> <p>L. 50 x p.48 x H.79</p>	ERT6			
 <p>Elemento 5 cassetti A - 1 B - 1 C 5 bacinelle - 2 fondi PVC 5 A - drawers, 1 B -drawer 1 C drawer unit 5 trays -2 PVC bottoms Elément 5 tiroirs A - 1 B - 1C 5 intérieurs de tiroirs-2 fonds en PVC</p> <p>L. 50 x p.48 x H.79</p>	ERT7			
 <p>Elemento 6 cassetti A - 2B 5 bacinelle-3 fondi PVC 6A - drawers - 2B 5 trays 1 -3 PVC bottoms Elément 6 tiroirs A - 2 B 5 intérieurs de tiroirs- - 3 fonds en PVC</p> <p>L. 50 x p.48 x H.79</p>	ERT8			
 <p>Elemento 2 ripiani estraibili portastrumenti antina a scomparsa 1 cassetto A- 1C 1 bacinella - 2 fondi in PVC Unit with 2 extractable surgical instruments holders disappearance door-1b drawer-1C 1 tray -2 PVC bottoms Elément 2 plans extractibles-instruments porte escamotable 1 tiroir B-1C 1 interieur de tiroirs - 2 fonds en PVC</p> <p>L. 50 x p.48 x H.79</p>	ERTEM2			

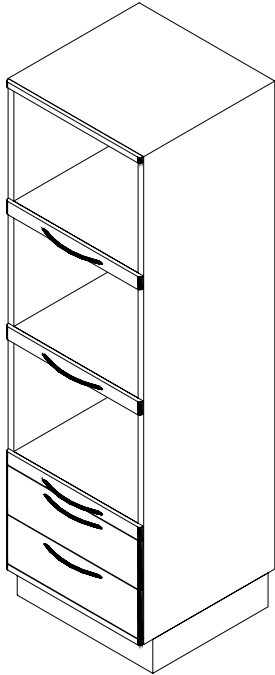
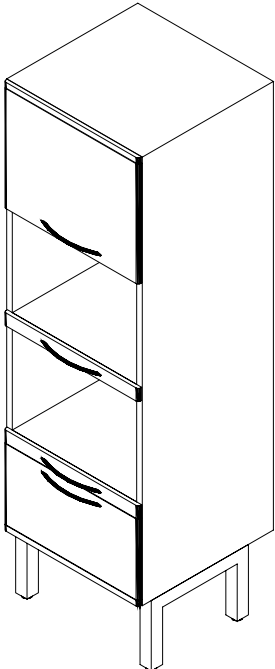
DESCRIZIONE description	ARTICOLO article	EURO
 <p data-bbox="293 976 962 1151"> Mobile colonna predisposto per 2 autoclavi e sigillatrice + 2 cassetti Tall unit arranged for 2 autoclaves and 1 thermo-sealing machine + 2 drawers Meuble colonne arrangé pour 2 autoclaves et 1 thermosoudeuse + 2 tiroirs </p> <p data-bbox="119 1171 292 1193">L.600 x p.600x H.2000</p>	COL/A	
 <p data-bbox="293 1944 962 2119"> Mobile colonna predisposto per 1 autoclave e 1 sigillatrice +1anta e un cassetto Tall unit with 1 door and drawer arranged for 1 autoclave and 1 thermo-sealing machine Meuble colonne avec 1 porte et 1 tiroir arrangé pour 1 autoclave et 1 thermosoudeuse </p> <p data-bbox="119 2128 292 2150">L.600 x p.600 x H.2000</p>	COL/P	

PENSILI - WALL UNIT - ARMOIRES MURALES

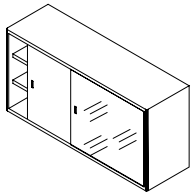
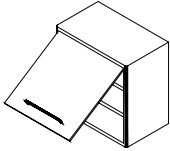
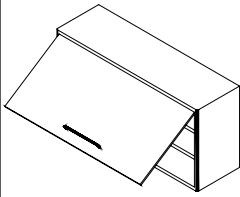
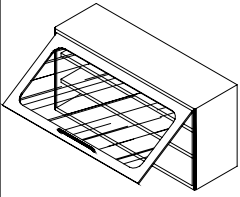
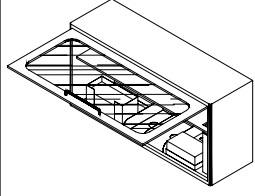
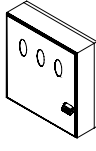
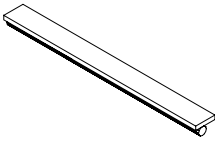
DESCRIZIONE description	ARTICOLO article	EURO
 <p>Pensile a vetri scorrevoli e 2 ripiani in cristallo Wall - unit with sliding plate - glass and 2 shelves Elément mural avec portes en verre coulissantes et 2 rayons internes</p> <p>L.100 x p.30 x H.50</p>	MV	
 <p>Pensile per sterilizzazione Sterilizing wall - unit Elément mural pour stérilisation</p> <p>L.50 x p.30 x H.50</p>	ST5	
 <p>Pensile per sterilizzazione Sterilizing wall - unit Elément mural pour stérilisation</p> <p>L.100 x p.30 x H.50</p>	ST4	
 <p>Pensile per sterilizzazione completo di lampada ultravioletti Sterilizing wall - unit with uv lamp Elément mural pour stérilisation avec ultra - violet</p> <p>L.100 x p.30 x H.50</p>	ST4/UV	
 <p>Dispenser di prodotti monouso Wall unit for disposable Distributeur mural pour produits jetable</p> <p>L.100 x p.30 x H.50</p>	PDM	
 <p>Gruppo igiene con dispenser di salviette, guanti, bicchieri, mascherine e distributore di sapone automatico Hanging unit equipped with automatic soap, napkins, gloves, mask and glass distributors Groupe hygiène équipé de distributeurs de savon automatique, serviettes, gants, masques et gobeletes</p> <p>L. 53x p. 13,5 x H.53</p>	PDMP	
 <p>Impianto di illuminazione da applicare sotto il pensile Lighting system under the wall - unit Installation de illumination pour mettre sous le élément mural</p>	ILL	50 cm 100 cm

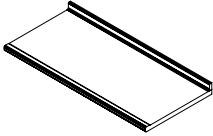
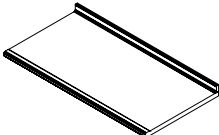
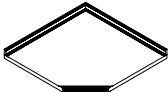
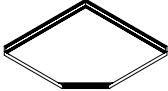
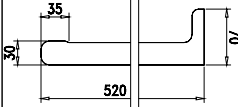
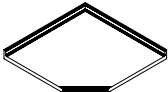
DESCRIZIONE description	ARTICOLO article	EURO
 <p>Piano top in laminato p.47 cm con alzatina applicata prezzo al m. lineare, addebito minimo 1 metro lineare Worktop d. 47 cm with sticked backsplash, per meter Plan postformé en laminé p. 47 cm avec dossier arrière, vendu au mètre linéaire, minimum 1 m</p> <p>L. 100 x p.47 x H.3</p>	PL47	
 <p>Piano top in laminato p.52 cm con alzatina applicata prezzo al m. lineare, addebito minimo 1 metro lineare Worktop d. 52 cm with sticked backsplash, per meter Plan postformé en laminé p. 52 cm avec dossier arrière, vendu au mètre linéaire, minimum 1 m</p> <p>L. 100 x p.52 x H.3</p>	PL52	
 <p>Piano top angolare in laminato 67x67 con alzatina applicata Angular laminar worktop 67x67 with sticked backsplash Plan angulaire en laminé 67x67 avec dossier arrière</p> <p>L. 67 x p.67 x H.3</p>	PA47	
 <p>Piano top angolare in laminato 72x72 con alzatina applicata Angular laminar worktop 72x72 with sticked backsplash Plan angulaire en laminé 72x72 avec dossier arrière</p> <p>L. 72 x p.72 x H.3</p>	PA52	
 <p>Piano top p.52 completo di alzatina incorporata e salvagoccia Worktop d.52 cm with integrated backsplash Plan en laminé p.52 cm. avec dossier postformé</p> <p>Sezione-curtaway view-vu en coupe</p>	PB52	
 <p>Piano top angolare 72X72 con alzatina incorporata Angular laminar worktop 72x72 with integrated backsplash Plan angulaire en laminé 72x72 avec dossier postformé</p> <p>L. 30 x p.47 x H.91</p>	PAB52	

PIANI IN VETRO - GLASS WORK TOPS - PLANS EN VERRE

DESCRIZIONE description	ARTICOLO article	EURO
<p>Piano in vetro con vasca in vetro integrata L. 150 x p. 52 cm Glass worktop with glass sink L. 150 x d. 52 cm Plan en verre avec vasque en verre L. 150 x p. 52 cm</p>		
<p>Piano in vetro con vasca in vetro integrata L. 200 x p. 52 cm Glass worktop with glass sink L. 200 x d. 52 cm Plan en verre avec vasque en verre L. 200 x p. 52 cm</p>		
<p>Piano in vetro con vasca in vetro integrata L. 250 x p. 52 cm Glass worktop with glass sink L. 250 x d. 52 cm Plan en verre avec vasque en verre L. 250 x p. 52 cm</p>		
<p>Piano in vetro angolare con vasca in vetro integrata 72 x 72 cm Angular glass worktop with glass sink 72 x 72 cm Plan en verre en angle avec vasque en verre 72 x 72 cm</p>		
<p>Piano in vetro sp. 15 mm al metro - Glass worktop price per meter - Plan en verre prix au mètre</p>		

PIANI IN ACCIAIO - STAINLESS WORKTOPS - PLANS EN INOX

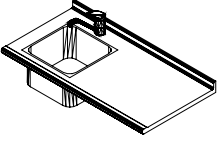
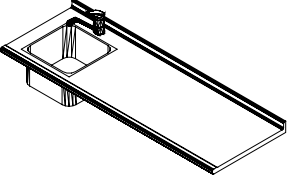
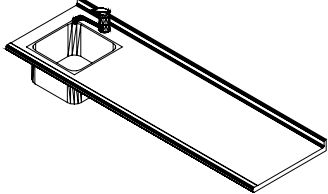
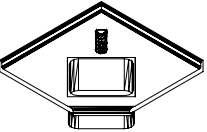
DESCRIZIONE description	ARTICOLO article	EURO
 <p>Piano inox con lavello e miscelatore Stainless steel worktop with sink and tap-mixer Plan en inox avec lavabo et mélangeur</p> <p>L. 150 x p.52 x H.3</p>	PILX1	
 <p>Piano inox con lavello e miscelatore Stainless steel worktop with sink and tap-mixer Plan en inox avec lavabo et mélangeur</p> <p>L. 200 x p.52 x H.3</p>	PILX2	
 <p>Piano inox con lavello e miscelatore Stainless steel worktop with sink and tap-mixer Plan en inox avec lavabo et mélangeur</p> <p>L. 250 x p.52 x H.3</p>	PILX3	
 <p>Piano inox angolare con lavello e miscelatore Angular stainless steel worktop with sink and tap-mixer Plan en inox en angle avec lavabo et mélangeur</p> <p>L. 72 x 72 x p.52 x H.3</p>	PILX4	

PIANI IN CORIAN - CORIAN WORKTOPS - PLANS EN CORIAN

DESCRIZIONE description	EURO
<p>Piano in corian con vasca in corian integrata L. 150 x p. 52 cm con alzatina raccordata Corian worktop with corian sink L. 150 x d. 52 cm with integrated backsplash Plan en corian avec vasque en corian L. 150 x p. 52 cm avec dossieret postformée</p>	
<p>Piano in corian con vasca in corian integrata L. 200 x p. 52 cm con alzatina raccordata Corian worktop with corian sink L. 200 x d. 52 cm with integrated backsplash Plan en corian avec vasque en corian L. 200 x p. 52 cm avec dossieret postformée</p>	
<p>Piano in corian con vasca in corian integrata L. 250 x p. 52 cm con alzatina raccordata Corian worktop with corian sink L. 250 x d. 52 cm with integrated backsplash Plan en corian avec vasque en corian L. 250 x p. 52 cm avec dossieret postformée</p>	
<p>Piano in corian angolare con vasca in corian integrata 72 x 72 cm Angular corian worktop with corian sink 72 x 72 cm Plan en corian en angle avec vasque en corian 72 x 72 cm</p>	
<p>Piano in corian sp. 15 mm al metro - Corian worktop price per meter - Plan en corian prix au mètre</p>	



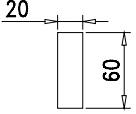
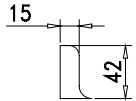
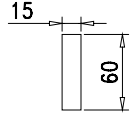
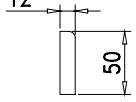
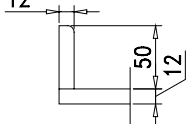
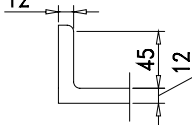

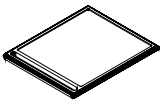
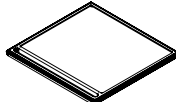
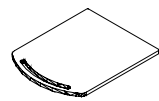
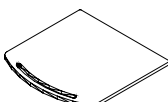
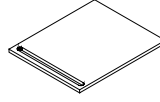
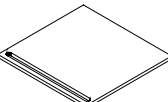

ALZATINE - BACKSPASHES - DOSSERETS

DESCRIZIONE description	EURO
 <p>Alzatina in acciaio al metro Stainless steel backsplash per meter Dossieret en inox au mètre</p>	
 <p>Alzatina in alluminio al metro Aluminium backsplash per meter Dossieret en aluminium un mètre</p>	
 <p>Alzatina in vetro al metro (massimo 2 metri) Glass backsplash per meter (max 2 meters) Dossieret en verre au mètre (max 2 mètres)</p>	
 <p>Alzatina in corian da siliconare al metro Corian backsplash to be stick per meter Dossieret en corian pour etre appliquée au mètre</p>	
 <p>Alzatina in corian applicata a 90° al metro Sticked 90° corian backsplash per meter Dossieret appliquée 90° au mètre</p>	
 <p>Alzatina in corian raccordata al metro Corian connected backsplash per meter Dossieret raccordée en corian au mètre</p>	

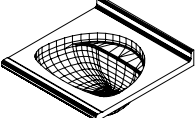
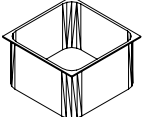
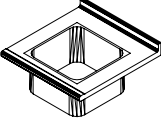

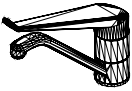
PIANI PER SERVOMOBILE - TOP FOR MOBILE ELEMENTS-PLAN POUR ELEMENTS SUR ROULETTES

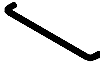
DESCRIZIONE description	40 cm	50 cm
<p>Piano in ceramica con maniglia per servomobile Ceramic top with handle for mobile element Plan en ceramique avec poignée pour element sur roulettes</p>		
<p>Piano in vetro con maniglia per servomobile Glass top with handle for mobile element Plan en verre avec poignée pour element sur roulettes</p>		
<p>Piano in corian con maniglia per servomobile Corian top with handle for mobile element Plan en corian avec poignée pour element sur roulettes</p>		

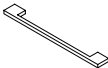
ACCESSORI - ACCESSORIES - ACCESSOIRES

DESCRIZIONE description	ARTICOLO article	EURO
 <p>Vasca in ceramica a filo piano Ceramic sink Vasque en ceramique</p>	VC	
 <p>Vasca in ceramica applicata sotto piano Ceramic sink applied under the top Vasque en ceramique appliquee sous le plan</p>	VCP	
 <p>Vasca inox a filo piano Stainless steel sink Vasque en inox</p>	VIX	
 <p>Vasca inox applicata sotto piano Stainless steel sink applied under the top Vasque en inox appliquee sous le plan</p>	VIXP	
 <p>Distributore di sapone Manual soap distributor Distributeur manuel de savon</p>	DS	
<p>KIT COMANDO ELETTROMAGNETICO 24V 24V electro-magnetic control kit Kit de commande eau electromagnetique 24V</p>	CE	
 <p>Miscelatore con leva lunga Long lever basin mixer Mélangeur avec levier clinique</p>	MLL	
 <p>Miscelatore con leva corta Single lever basin mixer Mélangeur</p>	MLC	
<p>Miscelatore elettronico completo con regolazione temperatura Complete electronic mixer with temperature adjustment Robinet infrarouge</p>	MEC	
 <p>Maniglia quadra Rectangular handle Poignée carrée</p>	MQ	
 <p>Maniglia ad arco Arc handle Poignée en arc</p>	MAR	
 <p>Maniglia rettangolare modello Elite Rectangular handle Elite model Poignée carrée Elite</p>	MARE	
<p>Pistone da 80N Piston 80N Piston 80N</p>	PI/80	
<p>Pistone da 160N Piston 160N Piston 160N</p>	PI/160	

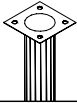
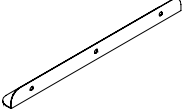
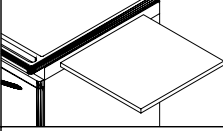
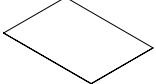
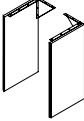

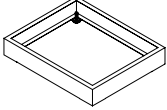
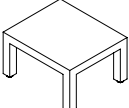
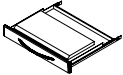
ACCESSORI - ACCESSORIES - ACCESSOIRES

DESCRIZIONE description	ARTICOLO article	EURO
 <p>Tubolare per sostegno ripiano Worktop support Pied de support pour plan de travail</p>	TUB	
 <p>Squadretta per sostegno ripiano Worktop supporting square Petite equerre de support pour plan de travail</p>	SQ	
<p>Presa di corrente Current tap Prise de courant</p>	PRC	
<p>Siringa ad aria + tubo + raccordo e boccia Air-nozzle with pipe + connection + box Soufflette avec tuyau + raccord et emplacement</p>	SIR	
 <p>Tavoletta estraibile Side extractable tablet Tablette latérale extractible</p>	TABEXT	
 <p>Fondo in PVC Pvc bottom Fond en Pvc</p> <p>L. 44.5 x p.33.2 x H.0.2</p>	FPVC	
 <p>Supporto laterale dx - sx di sostegno piano Bearing side to support the shelf Panneau latéral de soutien droit ou gauche</p>	SLS/SLD	
 <p>Pannello di chiusura posteriore Back pannel, meter price Panneau arrière meubles, au mètre</p>	PCP	
 <p>Pannello di chiusura fra muro e mobile Closing pannel between wall and unit Panneau de fond</p>	PMM	
 <p>Zoccolo per Serie Aurora Plinth for Aurora Serie Socle pour Serie Aurora</p>	ZOC/A	
 <p>Zoccolo per Serie Prestige Plinth for Prestige Serie Socle pour Serie Prestige</p>	ZOC/P	50 cm 100 cm 150 cm 200 cm
 <p>Cassetto A porta tastiera Drawer A - keyboard - holder Tiroir A porte - clavier</p> <p>L. 50 x p.47 x H.18,5</p>	CAPT	

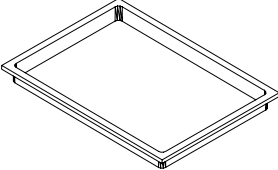
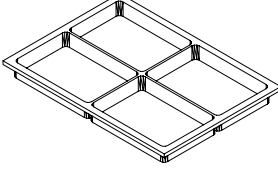
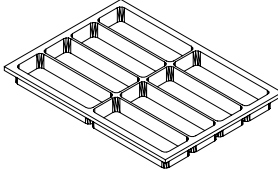
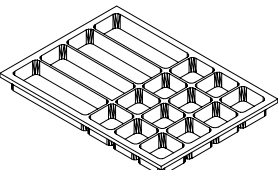
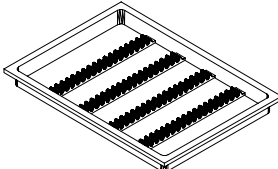
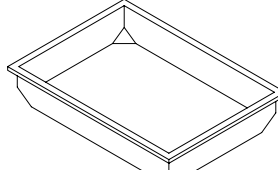
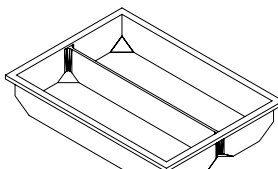
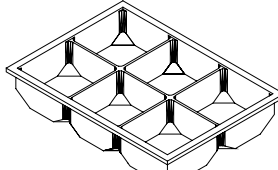
BACINELLE - BASINS - INTERIEURS

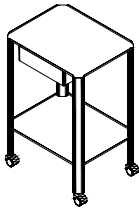

DESCRIZIONE description	ARTICOLO article	EURO
 <p>L. 45 x p.32 x H.37</p>	BA-A01	
 <p>L. 45 x p.32 x H.3,7</p>	BA-A04	
 <p>L. 45 x p.32 x H.3,7</p>	BA-A08	
 <p>L.45 x p.32 x H.3,7</p>	BA-A16	
 <p>L. 45 x p.32 x H.3,7</p>	BA-A36	
 <p>L. 45 x p.32 x H.8</p>	BA-B01	
 <p>L. 45 x p.32 x H.8</p>	BA-B02	
 <p>L. 45 x p.32 x H.8</p>	BA-B06	

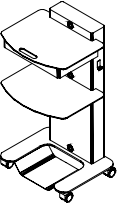
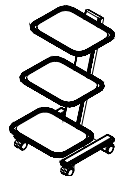
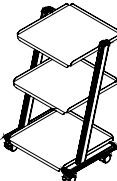
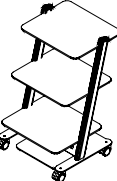
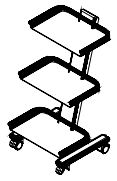
CARRELI DA STUDIO - TROLLEYS FOR DENTAL SURGERY - CHARIOTS POUR CABINETS MEDICAUX ET DENTAIRES

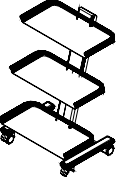
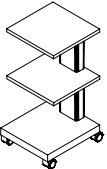
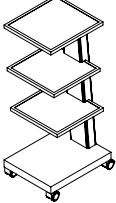
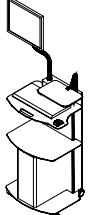
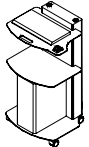



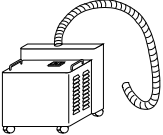
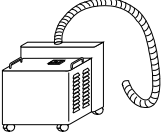

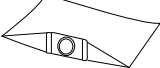
DESCRIZIONE description	ARTICOLO article	EURO
 <p>Carrello 2 ripiani e cassetto Trolley with 2 shelves and drawer Chariot avec 2 plans et 1 tiroir</p> <p>L.55 x p.43 x H.82</p>	C2R	
 <p>Carrello chirurgico piccolo 2 ripiani vetro e 3 prese di corrente Small surgical trolley with 2 glass shelves and 3 current taps Chariot chirurgie petit avec 2 étagères en verre et 3 prises de courant</p> <p>L.42 x p.34 x H.88</p>	C2RCHP	
 <p>Carrello chirurgico grande 2 ripiani vetro - 1 cassetto e 3 prese di corrente Maxi surgical trolley 2 glass shelves - 1 drawer an 3 current taps Chariot chirurgie maxi 2 étagères en verre - 1 tiroir et 3 prises de courant</p> <p>L.48 x p.38 x H.92</p>	C2RCHM	
 <p>Carrello 3 ripiani con 2 prese universali Trolley with 3 shelves and 2 current taps Chariot 3 plateaux et 2 prises normalisées</p> <p>L.40 x p.45x H.80</p>	C3R	
 <p>Carrello 3 ripiani con 3 prese universali Trolley with 3 shelves and 3 current taps Chariot 3 plateaux et 3 prises de courant</p> <p>L.49x p.37 x H.77</p>	C3RK	
 <p>Carrello 3 ripiani in vetro con 2 prese universali Trolley with 3 glass shelves and 2 current taps Chariot 3 plateaux en verre et 2 prises normalisées</p> <p>L49 x p.37 x H.77</p>	C3RV	
 <p>Carrello portastrumenti 3 ripiani - 1 cassetto con 2 prese universali Instruments holder trolley with 3 shelves- 1drawer and 2 current taps Chariot porte instruments 3 étagères - 1 tiroir et 2 prises de courant</p> <p>L.40 x p.54 x H.93</p>	C3RT	

DESCRIZIONE description	ARTICOLO article	EURO
 <p>Carrello portastrumenti 3 ripiani - 1 cassetto con 2 prese universali Instruments holder trolley with 3 shelves- 1drawer and 2 current taps Chariot porte instruments 3 étagères - 1 tiroir et 2 prises de courant</p> <p>L.50 x p.54 x H.93</p>	C3RTM	
 <p>Carrello portastrumenti 3 ripiani con 2 prese universali Instruments holder trolley with 3 shelves and 2 current taps Chariot porte instruments 3 étagères et 2 prises de courant</p> <p>L.35 x p.47 x H.78</p>	C3RQ	
 <p>Carrello 4 ripiani e 3 prese di corrente Trolley with 4 shelves and 3 current taps Chariot ave 4 étagérés et 3 prises de courant</p> <p>L.100 x p.30 x H.50</p>	C4RQ	
 <p>Carrello elettrificato porta PC/telecamera/monitor con ripiani in vetro Electrified PC holder trolley with glass shelves chariot électrifié porte PC avec étageres en verre</p> <p>L.56 x p.50 x H.129</p>	CPCV	
 <p>Carrello elettrificato porta PC/senza bracci con ripiani in vetro Electrified PC holder trolley without arms with glass shelves chariot électrifié porte PC sans bras avec étageres en verre</p> <p>L.56 x p.50 x H.94</p>	CPCV	

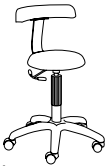
ASPIRAZIONE PORTATILE - PORTABLE SUCTION - ASPIRATION PORTATIVE

DESCRIZIONE description	ARTICOLO article	Euro
 <p>L. 38 x p.27 x H.34</p> <p>Aspirazione portatile per Laboratorio e Studio Portable suction unit for laboratory and studio Aspiration portative pour laboratoire et cabinet</p>	ZF/ET97	
 <p>L. 38 x p.27 x H.34</p> <p>Aspirazione portatile con automatico per Laboratorio e Studio Portable suction unit for laboratory and studio with automatic start Aspiration portative pour laboratoire et cabinet avec partance en automatique</p>	ZF/ET97P	
 <p>L. 50 x p.44.5 x H.79</p> <p>Elemento per aspirazione completo di protezione in plexiglas. Suction element complete with plexiglas protection Elément pour aspiration complet de protection en plexiglas</p>	CASP	
 <p>Sacchetto filtro per aspirazione Suction filtering bag Filtre à manche pour aspiration</p>	SF	
<p>Tubo per aspirazione - Suction tube - Tujau pour aspiration</p> <p>Motore per aspirazione - Motor - Moteur</p> <p>Filtro protezione motore - Motor protection filter - Filtre de protection du moteur</p>		

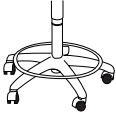
SEGGIOLINI DA STUDIO - STOOLS FOR DENTAL SURGERY - SIEGES OPERATEURS AVEC VERIN A GAZ

	DESCRIZIONE description	ARTICOLO article	Euro
 L. 55 x p.55 x H.90	Seggiolino mod. Classic con sedile girevole e regolabile in altezza (da cm. 50 a max cm. 65) - Comando alzata manuale Classic model stool with circular shaped swivel seat. Height can be regulated (from 50 to max. 65 cm.) - Manual-operated raising control Siège modèle Classic avec assise circulaire pivotante et réglable en hauteur (de cm. 50 à cm. 65 max) - Commande d'élévation à main	CL	-
 L. 55 x p.55 x H.90	Seggiolino mod. Future con sedile girevole regolabile in altezza (da cm. 45 a max cm. 60) - Comando a pedale Schienale regolabile girevole indipendente dal sedile Future model stool with circular shaped swivel seat. Height can be regulated (from 45 to max. 60 cm.) - Foot-operated raising control Adjustable swivel back, independent of the chair Siège modèle Future avec assise circulaire pivotante et réglable en hauteur (de cm. 45 à cm. 60 max) - Commande d'élévation à pied Réglage du dossier pivotant indépendant du siège	FU	-
ELEMENTI DA COMBINARE - ELEMENTS TO COMBINE - ELEMENTS A COMBINER			
 Ø. 34 x h.6	Seduta e schienale con imbottitura sottile Thin padded seat and back Assise et dossier avec rembourrage mince		
 Ø. 38 x h.8	Seduta e schienale con imbottitura spessa Thick padded seat and back Assise et dossier avec rembourrage épais		
	Base a 5 razze in ABS - colore: grigio o nero 5-spoke base made ABS - colour: grey or black Base avec 5 bras en ABS - couleur: grise ou noire		
	Poggiapiedi in acciaio per base ABS Steel footrest for ABS base Repose-pieds en acier pour base en ABS		+
	Base a 5 razze in acciaio 5-spoke base made of steel Base avec 5 bras en acier		+
SEDIE DA LABORATORIO - CHAIRS FOR LABORATORY - SIEGE POUR LE LABORATOIRE			
	Sedia girevole in faggio mod. Avant-Garde base a 5 razze in ABS nera con ruote Beechwood swivel chair Avant-Garde model 5-spoke base made of black ABS with wheels Siège pivotant en hetre modèle Avant-Garde base avec 5 bras réalisé en ABS noir avec roues	FGA	----

AMICO BOX

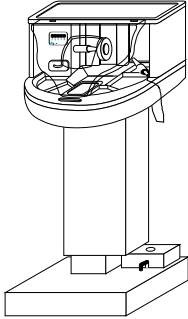
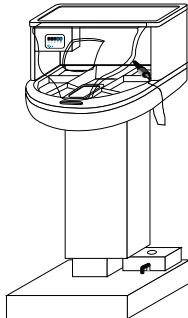
DESCRIZIONE description	ARTICOLO article	Euro
 <p>L. 50 x p.48 x H.112</p> <p>Elemento mobile per la rifinitura di strutture protesiche completo di:</p> <ul style="list-style-type: none"> - pulitrice monoalbero a 1400 giri/minuto - aspirazione silenziosa - lampada ad alta resa cromatica - interruttore generale e interruttori per l'accensione dei singoli apparecchi - protezione in policarbonato - base autofrenante a sostegno plantare - alloggiamento per qualsiasi marca di reostato e micromotore - sacchetto filtro in fibre sintetiche <p>PRODOTTO CERTIFICATO CE</p> <p>Prosthesis finishing unit equipped:</p> <ul style="list-style-type: none"> - 1.400 rpm single-shaft polisher - noiseless suction unit - lamp with high chromatic yield - master switch and switches for single appliances - polycarbonate protection - self-braking base to lay feet on - housing for any make of reostat and micromotor - filter bag made from synthetic fibres <p>EC CERTIFIED</p> <p>meuble pour le finissage des structures prothétiques équipé de :</p> <ul style="list-style-type: none"> - polisseuse mono-arbre à 1.400 tours-minute - système d'aspiration silencieux - lampe à haut rendement chromantique - interrupteur général et interrupteurs pour allumer chaque appareil - protection en polycarbonate - base autofreinante pour l'appui des pieds - logement pour une marque quelconque de rhéostat et micromoteur - filtre à sac en fibres synthétiques <p>PRODUIT CERTIFIE CE</p>	A BOX	
<p>Elemento mobile SX Movable unit SX Elément mobile SX</p>	B BOX	
 <p>L. 50 x p.48 x H.112</p> <p>Elemento mobile per la rifinitura di strutture protesiche completo di:</p> <ul style="list-style-type: none"> - aspirazione silenziosa - lampada ad alta resa cromatica - interruttore generale e interruttori per l'accensione dei singoli apparecchi - protezione in policarbonato - base autofrenante a sostegno plantare - alloggiamento per qualsiasi marca di reostato e micromotore - sacchetto filtro in fibre sintetiche - SENZA PULITRICE <p>PRODOTTO CERTIFICATO CE</p> <p>Prosthesis finishing unit equipped:</p> <ul style="list-style-type: none"> - noiseless suction unit - lamp with high chromatic yield - master switch and switches for single appliances - polycarbonate protection - self-braking base to lay feet on - housing for any make of reostat and micromotor - filter bag made from synthetic fibres <p>- WITHOUT CLEANING MACHINE</p> <p>EC CERTIFIED</p> <p>meuble pour le finissage des structures prothétiques équipé de :</p> <ul style="list-style-type: none"> - système d'aspiration silencieux - lampe à haut rendement chromantique - interrupteur général et interrupteurs pour allumer chaque appareil - protection en polycarbonate - base autofreinante pour l'appui des pieds - logement pour une marque quelconque de rhéostat et micromoteur - filtre à sac en fibres synthétiques <p>- SANS APPAREIL POUR LE NETTOYAGE</p> <p>PRODUIT CERTIFIE CE</p>	C BOX	

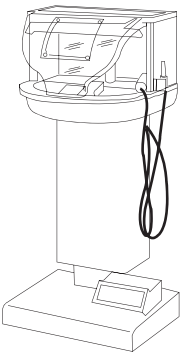
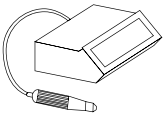
DESCRIZIONE description	ARTICOLO article	Euro
 <p>L. 50 x p.48 x H.112</p> <p>Postazione di lavoro da laboratorio per piccoli lavori di sgrossatura e tiratura di gesso, metalli e resina equipaggiato con:</p> <ul style="list-style-type: none"> - aspirazione regolabile (manuale o automatica) - lampada ad alta resa cromatica - caviglia regolabile - interruttore generale, interruttori per l'accensione della luce e dell'aspirazione - protezione in policarbonato per proteggere l'operatore dalle polveri nocive - base autofrenante a sostegno plantare - struttura su ruote per la massima maneggevolezza - sacchetto filtro in fibre sintetiche <p>Job's emplacement for laboratory for small jobs of rough shaping and pulling of chalk, metals and resin equipped with:</p> <ul style="list-style-type: none"> - adjustable aspiration (manual or automatic) - lamp to high chromatic yield - adjustable ankle - master switch, switches for the ignition of the light and the aspiration - polycarbonate protection in order to protect the operator from harmful powders - self-braking base to lay feet on - structure on wheels for the maximum ease of handling - filter bag made from synthetic fibres <p>Poste de travail pour laboratoire destiné aux retouches, grattage, et meulage de plâtre, métaux et résine équipé de :</p> <ul style="list-style-type: none"> - aspiration à variation manuelle ou réglage automatique - lampe à haut rendement chromatique - Cheville ajustable - Interrupteurs pour : "Mise sous tension" - "Eclairage" - "Aspiration". - Protection pour la poussière en polycarbonate - Base repose pieds auto bloquante - Base sur roulettes pour un positionnement dynamique - Sachet de récupération des déchets en fibre synthétique. 	LAB	
<p>MICROMOTORE - MICROMOTOR - MICROMOTEUR</p>		
 <p>Micromotore con alimentatore a pedale (Sirio) Micromotor with foot supply (Sirio) Micromoteur avec alimentation à pied (Sirio)</p>	MM	
<p>Kit in Plexiglas di protezione per Amico Box Plexiglas protection Kit for Amico Box Kit en plexiglas de protection pour Amico Box</p>	PA	
<p>Sacchetto filtro per Amico Box Filter bag for Amico Box Sachet filtre pour Amico Box</p>	SA	

AIR CAR

DESCRIZIONE description	ARTICOLO article	Euro
<div data-bbox="117 633 357 1021" data-label="Image"> </div> <div data-bbox="122 1025 307 1048" data-label="Caption"> <p>L. 50 x p.43 x H.80/95</p> </div> <div data-bbox="373 504 906 535" data-label="Section-Header"> <p>AIR CAR Elettropneumatico (modello base)</p> </div> <div data-bbox="373 566 867 716" data-label="Text"> <p>Carrello per studio dentistico equipaggiato con :</p> <ul style="list-style-type: none"> - siringa Luzzani - 2 uscite ad aria (per micromotore e turbina) - 2 uscite supplementari - regolabile in altezza da 80 a 95 cm </div> <div data-bbox="373 750 929 900" data-label="Text"> <p>Trolley (model base) for dental cabinet equipped with:</p> <ul style="list-style-type: none"> - Luzzani syringe - 2 air outlets (for micromotor and turbine) - 2 supplementary outlets - regular higher from 80 to 95 cm </div> <div data-bbox="373 934 945 1084" data-label="Text"> <p>Chariot (modèle base) pour cabinet dentaire équipé de:</p> <ul style="list-style-type: none"> - Seringue Luzzani - 2 sorties (pour turbine et micromoteur) - 2 sorties supplémentaires - réglable en hauteur de 80 à 95 cm </div> <div data-bbox="373 1146 482 1176" data-label="Section-Header"> <p>OPZIONI</p> </div> <div data-bbox="373 1211 937 1485" data-label="Text"> <p>Il carrello Air Car può essere personalizzato a richiesta su preventivo con:</p> <ul style="list-style-type: none"> - Micromotore elettrico con o senza fibre ottiche - Micromotore pneumatico - Turbina pneumatica con o senza fibre ottiche - Ablatore piezo elettrico - Lampada polimerizzatrice - Videocamera - Schermo al plasma </div> <div data-bbox="373 1547 920 1789" data-label="Text"> <p>Air Car trolley could be personalized on request with:</p> <ul style="list-style-type: none"> - Electric micromotor with or without optical fibres - Pneumatic micromotor - Pneumatic turbine with or without optical fibres - Piezo electric scaler - Photo-polymerization lamp - Camera - Plasma screen </div> <div data-bbox="373 1852 934 2094" data-label="Text"> <p>Air Car peut être personnalisé à la demande de chaque client avec :</p> <ul style="list-style-type: none"> - Micromoteur électrique avec ou sans FO - Micromoteur pneumatique - Turbine pneumatique avec ou sans FO - Détartreur piézoélectrique - Lampe pour polymérisation - Caméra vidéo </div>	<p>AIR CAR</p>	

AIR CAR

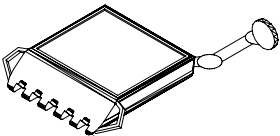
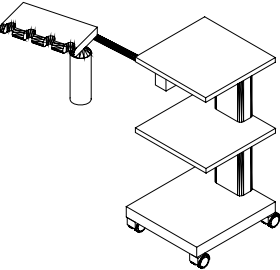
DESCRIZIONE description	ARTICOLO article	EURO
 <p>Riunito elettropneumatico/pneumatico con aggancio a muro Può essere personalizzato a richiesta su preventivo con:</p> <ul style="list-style-type: none"> - Micromotore elettrico con o senza fibre ottiche - Micromotore pneumatico -Turbina con o senza fibre ottiche - Ablatore piezo elettrico - Lampada polimerizzatrice - Videocamera - Schermo al plasma - Pedale a leva o a "schiacciare" <p>Air Car with wall hooking The Air Car could be personalized on request with:</p> <ul style="list-style-type: none"> - Electric micromotor with or without optical fibres -Pneumatic micromotor - Turbine with o without opticals fibres - Piezo electric scaler - Photo-polymerization lamp - Camera - Plasma screen <p>Air Car mural Il peut etre personnalisé à la demande de chaque client avec:</p> <ul style="list-style-type: none"> - Micromoteur électrique avec ou sans FO - Micromoteur pneumatique - Turbine avec ou sans FO - Détartreur piézoélectrique - Lampe pour polymérisation - Caméra vidéo 	<p>AIR MURAL</p>	
 <p>Mini riunito pneumatico su carrello con bottiglia spray+cordoni pendenti Personalizzabile con siringa 3F minimate, 2 tubi pneumatici e pedale a "schiacciare"</p> <p>Mini Air Car on castors with spray bottle+hanging tubes Personalizable with 3F minimate syringe and 2 pneumatic tubes</p> <p>Mini Air Car pneumatique sur chariot avec bouteille spray+cordons pendants Personalisé avec siringue 3F minimate et 2 tubes pneumatiques</p>	<p>MINI AIR CAR</p>	

IMBALLAGGI - PACKINGS - EMBALLAGES

DESCRIZIONE description	EURO
Imballo per carrello (scatola) Packing for trolley (paperboard) Emballage pour chariot (carton)	
Imballaggio per servomobile (pallet+cartone) Packing for element on castors (pallet+paperboard) Emballage pour element sur roulettes (pallet+carton)	
<p align="center"> IMBALLO CONSIGLIATO RECOMMENDED PACKINGS EMBALLEGES A CONSEILLER </p>	
Imballo per piano laminato o corian Packing for laminar or corian topwork Emballage pour plan en laminé ou en corian	
Imballo speciale per piano in vetro Special packing for glass worktop Emballage spécial pour plan en verre	
Empty space for additional entries	

CONDIZIONI GENERALI DI VENDITA

1) I prezzi degli articoli sono resi noti dal presente listino si intendono "al pubblico" I.V.A. esclusa. Per fatture di importo inferiore a 150,00 € verranno addebitate le spese per l'emissione dell'effetto bancario.

2) Tutte le ordinazioni si intendono assunte salvo il venduto e salvo buone informazioni.

3) La merce viaggia a rischio e pericolo del committente anche se venduta franco destino.

4) La consegna si intende fatta al compratore, a tutti gli effetti, all'atto dell'uscita della merce dai nostri magazzini, venendo con ciò a cessare ogni Nostra responsabilità.

5) Non rispondiamo di conseguenza dei ritardi, disguidi, perdite, avarie comunque derivanti dal mezzo di trasporto, né dalla scelta di esso, i reclami contro il vettore debbono essere esercitati dal destinatario.

6) La ZILFOR si riserva la facoltà di evadere le commissioni anche in più riprese.

7) I termini di consegna assumono per la ZILFOR valore puramente indicativo e non vincolante.

8) Il mancato arrivo delle materie prime adatte va considerato come caso di forza maggiore. In tutti i casi di forza maggiore la ZILFOR ha la facoltà di annullare o ritardare l'esecuzione della commissione senza che il committente possa pretendere alcun indennizzo.

9) Non si accettano reclami se non fatti per lettera raccomandata entro tre giorni dall'arrivo della merce. Per nessun motivo il compratore potrà rifiutarsi allo svincolo delle merci in arrivo; le soste e i conseguenti danni causati dal suo eventuale rifiuto saranno a completo suo carico.

10) La garanzia su eventuali difetti di materiale o fabbricazione segue le disposizioni legislative ed ha una validità di mesi 12 decorrenti dalla data di consegna (o data DDT).

11) Non si accettano ritorni di merci se non sono stati previamente autorizzati dalla ZILFOR. Il ritorno viene effettuato solo se la merce è imballata in modo da garantire il trasporto senza ulteriori danni e dovrà essere dotata di regolare documento di accompagnamento, ove dovrà risultare per ciascun articolo il tipo, il colore, la quantità, il numero e la data della fattura di acquisto. L'accredito della merce ritirata viene fatto in base ai prezzi d'acquisto e tenendo conto dello stato di ciascun elemento reso, valutato a insindacabile giudizio del Nostro Ufficio Tecnico.

12) Anche in caso di contestazione di qualsiasi genere e segnalata nel modo richiesto, permane il diritto per la ZILFOR di richiedere l'integrale pagamento della fornitura.

13) Per qualunque caso di contestazione unico foro competente è quello di Treviso.

14) In caso di mancato pagamento, salvo ogni nostro diritto, decorrerà l'interesse commerciale.

15) Il mancato pagamento di una scadenza o la mutata situazione del compratore daranno diritto alla ZILFOR di annullare senz' altro ogni contratto esistente.

16) La merce rimane fino al suo pagamento di proprietà della ZILFOR che ha la facoltà di ritirarla.

17) Gli elementi fuori serie per dimensioni, per materiale e/o colore devono essere preventivamente accettati dal nostro Ufficio Tecnico sia per la possibilità del tempo di realizzo, sia per la determinazione del prezzo di vendita.

18) La ZILFOR declina ogni responsabilità per l'errato montaggio in loco dei suoi articoli non eseguiti dal proprio personale.

19) La conformità "al campione" sia per la prima che per le successive forniture non va intesa in senso restrittivo giacché sussistono margini di tolleranza di regola riconosciuti per i vari materiali impiegati.

20) La ZILFOR si riserva il diritto di variare in qualsiasi dettaglio gli articoli e i prezzi descritti nel presente listino senza doverne dare preavviso alla clientela.

21) Si prega di citare negli ordini il codice completo di ogni prodotto e il relativo prezzo.

22) I depliant in circolazione hanno carattere puramente illustrativo e, pertanto, la ZILFOR declina ogni responsabilità per eventuali inesattezze di stampa o per errate indicazioni sulle caratteristiche del prodotto .

23) Le consegne sul territorio nazionale relative a ordini di importo totale netto inferiore a € 800,00 vengono effettuate esclusivamente in porto assegnato. Per cifre superiori il trasporto sarà trattato a parte, indipendentemente dalle modalità di addebito, la merce si intende consegnata al piano cortile, tiro al piano escluso, salvo diverso accordo.

24) I prezzi riportati non comprendono il montaggio che, qualora richiesto, sarà sempre quotato a parte.

CONDITIONS OF SALE

1) The prices of the articles are indicated in this price list and are the "retail prices" excluding VAT.

2) All orders are accepted sale excepted and under usual reserve.

3) The goods travel at the buyer's risk even if sold delivery free.

4) Delivery is made, to all effects, to the buyer at the moment the goods leave our warehouses, all liability for us thus ceasing from that moment on.

5) We cannot be held responsible for the consequences due to delays, miscarriages, losses, damages resulting from the means of transport, neither from the choice of the same; complaints about the carrier must be made by the consignee.

6) ZILFOR reserves the right to handle orders also in several instalments.

7) For ZILFOR, the terms of delivery are given purely as an indication and are not binding.

8) Failure of suitable raw materials to arrive is considered as Force Majeure. In all cases of Force Majeure, ZILFOR has the right to cancel or delay the completion of orders, without the buyer having the right to claim compensation.

9) No complaints are accepted unless sent by registered letter within 3 days from the arrival of the goods. For no reason whatsoever may the buyer refuse to clear the incoming goods, while the demurrage and consequent damage caused by his eventual refusal shall be fully charged to him.

10) The guarantee of possible defects about material or concerning the manufacturing follows lowgiving dispositions and has 12 month's validity from delivery date (or from transport document).

11) Returned goods will not be accepted unless previously authorised by ZILFOR. Returns are only accepted if the goods are packet in such a way as to guarantee carriage without further damage and shall have a regular packing list, in which the type, colour, quantity, number and date of purchase invoice for each article shall be specified. Credit for the returned goods is made on the basis of the purchase prices and taking into consideration the state of each returned element, assessed by our Technical Office, whose decision is final.

12) Also in the case of contestation of any kind whatsoever and notified in the requested manner, ZILFOR still has the right to ask for full payment of the supply.

13) The only court of competent jurisdiction for any dispute whatsoever is Treviso.

14) In the event of non- payment, all our rights being applicable, commercial interest shall be applied.

15) Non-payment at a due date or the changed situation of the buyer shall give ZILFOR the right to cancel without further delay all existing agreements.

16) The goods remain the property of ZILFOR, who have the right to withdraw them, until full payment is made.

17) The elements which are custom-made with regard to dimensions, material and/or colour must be previously accepted by our Technical Office with regard to feasibility, time required for production and calculation of the sale price.

18) ZILFOR cannot be held responsible for incorrect assembly of its articles on site unless carried out by its own personnel.

19) Conformity "to the sample" both for first and subsequent supplies should not be interpreted in a restrictive way, since there are normally recognized margins of tolerance for the various materials used.

20) ZILFOR reserves the right to alter any detail of its articles and the prices indicated in this price list without warning its customers.

21) When ordering you are requested to quote the complete code number of each product and the relative price.

22) Brochures have the sole purpose of illustrating the product and ZILFOR therefore cannot be held responsible for any printing inaccuracies or wrong indications regarding product specifications.

23) Deliveries on national territory relating to orders with a net total amount of less than € 800,00 must be made exclusively carriage unpaid. For higher amounts, carriage shall be negotiated separately, independently of the methods of debiting, the goods being delivered to the ground floor, haulage to upper floors excluded, unless otherwise agreed.

24) The listed prices do not include assembly which, when requested, is always quoted separately.

CONDITIONS GENERALES DE VENDE

1) Les prix des articles sont divulgués par cette liste des prix; ils s'entendent "au publique", avec TVA française.

2) Les commandes s'entendent acceptées, sauf le vendu et sauf bons renseignements.

3) La marchandise voyage aux risques et périls de l'acquéreur, même si vendue franco à destination.

4) La livraison s'entend effectuée à l'acquéreur, à tous les effets, au moment de la sortie de la marchandise des nos magasins; cessant par cela toute responsabilité de notre part.

5) Nous ne répondons pas des conséquences causées par les retards, erreurs, pertes ou avaries dérivant aussi bien du moyen de transport que de la choix de celui-là; toute réclamation au transporteur doit être exercée par le destinataire.

6) ZILFOR se réserve le droit d'exécuter également les commandes même par plusieurs livraisons partielles.

7) Les conditions de livraison ont pour ZILFOR une valeur purement indicative et non contraignante.

8) La non-livraison des matières premières appropriées constitue un cas de force majeure. Dans tous les cas de force majeure ZILFOR a la faculté d'annuler ou de retarder l'exécution de la commande sans que le client puisse exiger une indemnité.

9) On n'accepte autre réclamation que par lettre recommandée dans un délai trois jours dès réception de la marchandise. Pour aucune raison l'acheteur ne pourra se refuser d'accepter les marchandises entrantes; les arrêts et les dommages conséquents causés par un refus éventuel seront entièrement à sa charge.

10) La garantie concernant éventuels défauts du matériel ou de fabrication suite les dispositions législatives et a une validité de 12 mois à partir de la date de livraison (ou date document de transport).

11) Aucune marchandise de retour ne sera acceptée si ZILFOR ne l'a pas autorisé préalablement. Le retour sera effectué seulement si la marchandise est emballée de façon à garantir son transport sans dommages ultérieurs. Elle devra être accompagnée du document d'accompagnement régulier, où l'on mentionnera le type, la couleur, la quantité, le numéro et la date de la facture d'achat de chaque article. L'avoir relatif à la marchandise retirée sera calculé sur la base des prix d'achat, en prenant en considération l'état de chaque élément rendu, évalué sur la base de la décision sans appel de notre Service Technique.

12) Même en cas de contestation, de quelle que nature que ce soit, et signalée de la façon requise, ZILFOR garde également le droit de demander le paiement intégral de la commande.

13) Dans tous les cas de contestation le tribunal de Treviso est le seul compétent.

14) En cas de non-paiement, sauf tous nos droits, on va calculer l'intérêt commercial.

15) Le non-paiement d'une échéance ou la situation changée de l'acquéreur donneront à ZILFOR le droit d'annuler tout contrat existant.

16) Jusqu'à son paiement, la marchandise reste propriété de ZILFOR qui a faculté de la retirer.

17) Tout élément hors série par dimensions, matériau et/ou couleur doit être accepté préalablement par notre Service Technique en ce qui concerne la possibilité du temps de réalisation, et la détermination du prix de vente.

18) ZILFOR décline toute responsabilité pour l'incorrect monitoring sur place de ses articles qui n'a pas été effectué par son personnel.

19) La conformité "à l'échantillon", aussi bien pour la première fourniture que pour toute fourniture suivante, ne s'entend pas dans un sens restrictif, puisque il y a des marges de tolérance qui en règle générale sont reconnus aux différents matériaux employés.

20) ZILFOR se réserve le droit de modifier tout détail de ses articles et les prix indiqués dans cette liste des prix, sans devoir en donner le préavis à sa clientèle.

21) Nous vous prions d'indiquer le code complet de chaque produit et le prix correspondant dans la commande.

22) Les dépliants en circulation sont à caractère purement explicatif; ZILFOR décline toute responsabilité pour les inexactitudes d'impression éventuelles ou pour des indications incorrectes des caractéristiques du produit.

23) Toute livraison sur le territoire national relative à des commandes dont le montant net total est inférieur à € 800,00 est effectuée exclusivement en port du. Pour des montants supérieurs le transport sera déduit à part, indépendamment des modalités de débit. Il est entendu que la marchandise est livrée au niveau de la cour, livraison à l'étage non-compris, sauf accords différents.

24) Les prix indiqués ne comprennent pas le montage. Sur demande, on fera toujours une cotation séparée.